

Final

CPA Project Application Form

[CPC Use Only: Date Received 2/20/24 By: Katie Berry
Assigned CPC #2025- 016]

If possible, use word processor to fill out form. Please answer all questions, use "N/A" if not applicable.

- a.) Applicant Name and Organization: Last Haddad First Mark
Organization(s) (if appropriate) Town of Groton Town Manager
- b.) Regional Project: Yes ? or No? ? If Yes, Town/Organization: _____

- Submission Date: 02/22/2024
- Applicant Address: St. 173 Main Street
City/ State: Groton, MA ZIP: 01450
- Ph. #978-448-1111 Email: mhaddad@grotonma.gov
- CPA Purpose. Check all that apply:
Community Housing ? (Affordable Housing: ? Historic Preservation*: ? Open Space: ?
Recreation X
- * As per MA General Law Chapter 44B, proposed historic projects that are not on the structures listed on the state's registry of historic places require a determination by the Groton Historic Commission that the proposed project is of historic significance.*
- Town Committee or boards participating: Select Board and Department of Public Works
- Project Location/Address: 32 Playground Road, Groton, MA 01450
- Project Name: Outdoor Fitness Court
- Additional Responsible Parties (If applicable):

Role (specify)	Name	Address	Ph. (w) (cell)	Email
Property/Site Owner	Town of Groton	173 Main Street, Groton, MA 01450	978-448-1111	selectboard@grotonma.gov
Project Manager	Mark Haddad	173 Main Street, Groton, MA 01450	978-448-1111	mhaddad@grotonma.gov
Lead Architect	TBD			
Project Contractor	TBD			
Project Consultants	TBD			
Other:				
Other				

- As appropriate, indicate if proposal requires P&S agreement ? Deed ?
Option agreement ? Other-describe: _____
- a.) Assessor info. (map/ block/ lot id.(s)): 113/23 b.) Tax classification type: _____
- Permits required: Zoning: _____ Historic Preservation: _____ Other: Various permits, including a Building Permit
- Historic Commission Approval signoff (when required): _____ Date: _____
- a.) Project cost \$287,500 : Estimate ? Professional quote X b.) Requested from CPC: \$237,500 c.) Committed from other source: \$ 50,000 If applicable: annual anticipated total income: \$ _____ Annual anticipated total expense: \$ \$287,500 Anticipated net income (loss): \$ _____ Name of Estimator name/company: National Fitness Campaign

15. CCP Objectives - use codes from **Section 5 of Community Preservation Plan** to indicate all that apply: 5-3 Open Space and Recreation

16. Project Timelines: Proposed Start Date: 7/2/2024 Projected Complete Date: 12/31/2024

17. Estimated Delivery Date of Completion Report to CPC: 12/31/2024

18. Project description and explanation (attach additional sheets as needed): _____

See attached explanation

19. Feasibility: Town of Dracut used \$170,000 in CPA Funds for their outdoor fitness court and the Town of Chelmsford used \$135,000 in CPA Funds for their outdoor fitness court.

20. List of attachments: Notice of Grant Award; 2022 National Fitness Campaign Impact Report; 2024 Campaign Funding Requirements; Approved installation Network; Fitness Court Accessibility Overview; Concrete Slab Installation Requirements; Park Commission Meeting Minutes; Map of location of Fitness Court; Letters of Support

21. Additional Information: _____

22. Management Plan: The Town Manager, as Chief Procurement Officer, will oversee the project. Public Bidding will take place based on the specifications developed by the National Fitness Campaign. The DPW will be responsible for the Site Work.

23. Applicant Signature:  Date: 2-21-24

Co Applicant Signature: _____ Date: _____

Co Applicant Signature: _____ Date: _____

2023-2024 CPA Application Summary

Outdoor Fitness Court Summary

In the Spring of 2023, the Town of Groton applied for and received a \$50,000 2024 BlueCross, BlueShield Massachusetts Fitness Campaign Grant Award. Attached is the Notice of Award. The 2024 Blue Cross Blue Shield Massachusetts Campaign is part of a national movement to make world-class fitness free and accessible in public spaces across the country, which is more important today than ever before. National Fitness Campaign (NFC) is a for-profit wellness consulting firm. NFC's mission is to make "world class fitness free" to support healthy communities across America. This grant provides seed funding for the construction/installation of an Outdoor Fitness Court on Town owned property. The original idea was to construct the Court on the former Squanacook Sportsmen's Club Property that abuts the Center in West Groton. However, due to a conservation restriction on the property, placing it there is no longer feasible.

The Town did a thorough review of all Town owned property to determine the best location for this Fitness Court. Working cooperatively with the Groton Park Commission, it was determined that the best location is at 32 Playground Road, also known as Town Field (behind the Groton Public Library), adjacent to the outdoor basketball court. Please see attached Site Map showing the location. At the regularly scheduled meeting of the Groton Park Commission held on Tuesday, December 12, 2023, the Commission voted unanimously to approve the Court at this location (see attached minutes of the Meeting).

As stated, the Grant provides seed money for the Outdoor Fitness Court, along with the specifications for the concrete slab, installation requirements and accessibility overview. To assist the Community Preservation Committee in understanding the Campaign, also attached to this Summary is a copy of the 2022 National Fitness Campaign Impact Report. It provides an overview of the Campaign and how it has been accepted and implemented throughout the Country. In addition, the following supplemental information is attached for your review:

1. Concrete Slab Requirements (to be installed by the DPW)
2. Fitness Court Accessibility Overview
3. NFC Approved Installation Network
4. 2024 Funding Requirement

With regard to the required funding, please consider the following budget for the project:

NFC Program – Fitness Campaign Services/Equipment	\$145,000 (total cost of \$195,000 that is offset by \$50,000 Grant)
Concrete Slab Cost	\$40,000
Installation Team Cost	<u>\$32,500</u>
Total Cost:	\$217,500

I requested \$237,500 to include a 10% contingency. I hope this information is helpful. I look forward to working with the Community Preservation Committee as we move forward with this application.



Congratulations!

Groton, MA has been selected as a 2024 Blue Cross Blue Shield Massachusetts Campaign Grant Recipient!

Dear Mark,

On behalf of the National Fitness Campaign Grant Committee, we are pleased to share that Groton, MA has been selected as a grant eligible partner in the 2024 Blue Cross Blue Shield Massachusetts Campaign! This notification letter confirms eligibility for one (1) 2024 NFC Grant of \$50,000, with an opportunity to leverage (1) 2023 NFC Grant of \$50,000 this year. The next step is to schedule your official Grant Eligibility Award Call within the next 10 days, where the qualifications submitted in your Grant Application will be confirmed by the NFC team, and your Grant Program Requirements (GPR) will be aligned for eligibility and participation in this year's campaign. A copy of your GPR Document is attached to this formal award letter for your review, and is based on dates submitted in your Grant Application.

The \$50,000 Grant Award will be confirmed pending 1) the submission of a Resolution of Adoption, endorsed by your local governing body or appropriate council, and a countersigned copy of the attached formal GPR document within 60 days of the Award Call, 2) authorization to proceed, documented by formal funding confirmation (commonly a purchase order) and 3) confirmation of a scheduled shipping date for the Fitness Court and appropriate storage plans. Once set, GPR milestones must be met in order to maintain funding eligibility in the campaign.

To support this partnership and align your GPR milestones with your community's local adoption and funding processes, we have assigned a Partnership Manager – David Chavez – as your dedicated partner and champion in support of this partnership. Over the coming months, David will work with your team to support the path outlined in the GPR Document, assisting in the confirmation of required remaining funding, installation, and launch of your program.

The 2024 Blue Cross Blue Shield Massachusetts Campaign is part of a national movement to make world-class fitness free and accessible in public spaces across the country, which is more important today than ever before – thank you for your commitment to supporting this goal.

Here is a sneak peek at what's ahead:

- Fitness Court® Launch – Cut the ribbon on your beautiful new outdoor gym & announce free fitness to the community!
- Classes & Challenges – Get residents moving & keep them engaged with ongoing group classes, individual training, and competitive events.
- Press & Promotions – Shine a spotlight on your community and local partners for joining this exciting and innovative wellness movement!

Once again, we are thrilled to invite you to join us as a partner in the 2024 Blue Cross Blue Shield Massachusetts Campaign, and we look forward to making world-class fitness free in Groton, MA!

Best in Fitness,

A handwritten signature in blue ink, appearing to read "Mitch Menaged".

Mitch Menaged, Founder



Groton, MA - National Fitness Campaign 2024 Funding Cycle Grant Program Requirements (G.P.R.)

MILESTONE 1: ADOPTION

- **Summary:** Commit to project adoption and confirm matching funding
 - **Requirement A:** Countersigned Grant Program Requirements Document
 - **Deadline:** 4/04/2023
 - **Requirement B:** Resolution of Adoption or Letter of Support
 - **Deadline:** 5/22/2023
- *Purchase Order Will Satisfy Adoption Requirement if Submitted Within 60 Days of Grant Award

MILESTONE 2: AUTHORIZATION TO PROCEED - FUNDING CONFIRMED

- **Summary:** Execute budgeting and fundraising plan (as needed) and confirm total required funding
 - **Requirement:** Funding confirmation document submitted to NFC for remaining program funding (typically P.O)*
- *Refer to Official Quote and Funding Requirements Summary for details
- **Deadline:** 7/10/2024

MILESTONE 3: SHIPMENT FOR STORAGE

- **Summary:** Identify Fitness Court® storage location and schedule Fitness Court® delivery
- **Requirement:** Accept Fitness Court® delivery and store at a secure location, prepare to be invoiced for program funds
- **Deadline:** 7/15/2024 - 8/02/2024

MILESTONE 4: INSTALL CONCRETE SLAB & ART APPROVAL

- **Summary:** Review slab drawings & schedule concrete installer, confirm Fitness Court orientation, Approve art print preview
- **Requirement:** Install concrete slab (*cure time of 28 days before Fitness Court® installation*)
- **Deadline:** June 2024 - pending weather

MILESTONE 5: FITNESS COURT® ASSEMBLY

- **Summary:** Select Fitness Court® Assembly Team - NFC'S Installation Network is recommended, (includes art install)
- **Requirement:** Confirm installation timeline with NFC, provide completed installation photos for NFC inspection
- **Deadline:** July 2024 - pending weather

MILESTONE 6: PRESS LAUNCH CEREMONY

- **Summary:** hold Fitness Court® press launch event & ribbon cutting
- **Requirement:** Promote press release, hold launch event within campaign year (weather permitting)
- **Deadline:** August 2024 - pending weather

Trent Matthias, Director
National Fitness Campaign

Mark Haddad, Town Manager
Groton, MA

It is noted by the National Fitness Campaign and the municipality, school or organization listed above that this document in no way constitutes a binding agreement, or requirement to proceed with the NFC Program at any time. Formal commitment occurs upon receipt of complete local match funding by the program awardee, with submission of Funding Confirmation Documentation to National Fitness Campaign.

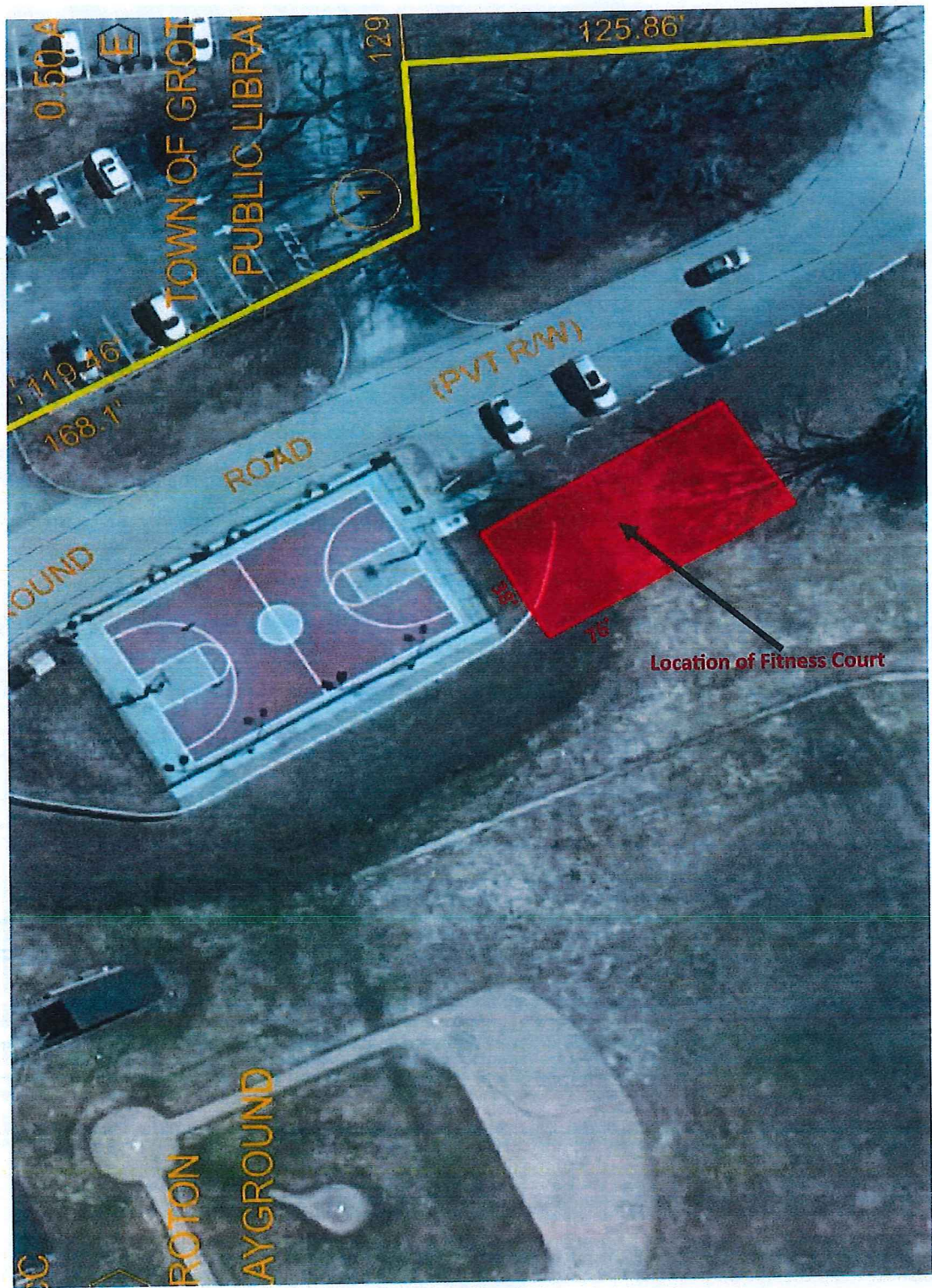

0.50A

E

TOWN OF GROTON
PUBLIC LIBRARY

129

125.86'

119.46
168.1'

GROUND

ROAD

(PVT R/W)

Location of Fitness Court

PROTON
PLAYGROUND



TOWN OF GROTON
Park Commission
Town Hall
1st Floor Meeting Room

PARK COMMISSION
Brenden Mahoney, Chair
Anna Eliot, Vice Chair
Mary Jennings, Member
Jeffrey Ohringer, Member
Gail Chalmers, Member

Date: Tuesday, December 12, 2023
Time: 1:00 PM
Location: 1st Floor Meeting Room
Members Present: Brenden Mahoney, Anna Eliot, Mary Jennings, Jeffrey Ohringer, Gail Chalmers
Members Not Present:
Others Present: Katie Berry, David Pitkin, John Reilly, Rob Foley, Mark Haddad, Kara Cruikshank, Fran Stanley

Brenden Mahoney called the meeting to order at 1:00 p.m.

Town Manager Updates (MARK HADDAD)- Mark Haddad addressed the Park Commission in regards to a grant that was received by the town for a Blue Cross Blue Shield fitness court. The grant amount received from BCBS was \$50,000, with a CPA Project application (2025-06) for the balance of \$237,000. The project initially was to be placed next to the Groton Center, though a conservation restriction would make that location not an option. After reviewing sites throughout town, Mr. Haddad is proposing placing the fitness court instead behind the library, on the left of the basketball court, beside Town Field. The site footprint would be 35' x76', the DPW director, Tom Delaney has confirmed feasibility for the site, and for various reasons agreed that, this would be an ideal location. Brenden Mahoney also made mention that the project could include a splash pad for children, based on the location of the water line infrastructure. Mr. Mahoney added that this would be excellent timing as Town Field will be having baseball field diamond work done soon and that he has had a discussion with a local contractor to discuss a potential design. Gail Chalmers clarified that the fitness court would be for adults and seniors, not for young children, Mr. Haddad confirmed this, and noted that it will also be handicap accessible. Jeff Ohringer asked about possibility for vandalism, to which Mr. Haddad gave greater detail about the structures and design. Mary Jennings clarified that the CPA application in the amount of \$237,000 would cover the remaining expense of the fitness court and not for the splash pad and concept design. Rob Foley addressed the commission to ask when the baseball field diamond project will begin, which hasn't been determined, though the two projects could be done concurrently. Mark Haddad stated that the fitness court could not begin until July 1, 2024, at the start of FY25. Rob Foley shared some information about the condition of the current Town Field play areas, which need repair, as well as fencing changes. Anna Eliot made comments about engaging a designer and the potential need to form a committee in order to work on a concept plan. Mary Jennings motioned to approve Mark Haddad's request to select Town Field as the location for the fitness court project, Jeff Ohringer seconded, and motion carried unanimously.

Mark Haddad addressed the committee with his second update, to share that the town is in a deficit of 3 million dollars, and if the override proposition 2 1/2 does not get approved, there will be significant cuts to many departments. Mr. Haddad stated that the Park Commission Expense Budget of \$55,579.00 per year, would be cut if that situation happens, and the town would

contact user groups for financial assistance in maintaining the fields. Mr. Haddad also stated that the Park Commission Capital Budget would remain and is presently set at \$50,000.00 for FY25. For Mark Haddad's last update, he asked the commission if a bay at Town Field could be used by Paul Funch of the Trails Committee, to house a piece of equipment for trail creation and repair. Jeff Ohringer offered the old pump house at Cow Pond, if any committee would like to move it to a new location. Mark Haddad thanked the commission for their time and apologized for the potential loss of the expense budget, should the override not pass.

CPA Application 2025-02 Cow Pond Play Fields Discussion-Request for Letters of Support (ANNA ELIOT)- Anna Eliot shared details about the application, and the need for concept design at Cow Pond Fields, requesting letters of support for the project from user groups. Brenden Mahoney shared that Katie Berry, Park Commission Administrator, had sent out a Google survey to get responses from the public as to what they would like to see at the Cow Pond area. David Pitkin asked Anna Eliot if the new CPA Project 2025-02 is as a result of the previous CPA project 2022-02 for feasibility. Brenden Mahoney asked David Pitkin if the traffic flow has been improved since the DPW made adjustments at the Cow Pond site parking area, to which he said yes.

Maple Ave Property Discussion (MARY JENNINGS)- Mary Jennings shared that she became aware of a site at parcel 104-31 Maple Ave, which belongs to the Park Commission, Katie Berry confirmed with the Groton GIS.

Green Pickup Bags for Dogs Visiting Field Areas (BRENDEN MAHONEY)- Brenden Mahoney shared that he has researched purchase of green refuse bags for dog waste, and gave pricing to the commission members. Jeff Ohringer stated that dogs using the Cow Pond field as a bathroom has been a major problem. During the winter months, there are no trash receptacles to put the green bags in. Brenden Mahoney mentioned that creating a dog area at Cow Pond, may help with this issue, which could be part of the concept design. Rob Foley shared that the dogs making a mess is a major issue for the user groups and players. Brenden Mahoney noted that the green bags information has been presented, that the commission can review it and make an educated decision. Mr. Mahoney stated that the discussion of dogs on fields will be continued.

Affordable Housing Trust project at parcel 249-51 (BRENDEN MAHONEY) – Brenden Mahoney shared the intention of the Affordable Housing Trust, to move forward with building a single structure on this parcel.

General Condition of Park Properties- Commissioner updates and estimates.

Town Fields/ New Town Common/ Minuteman Common/Orchard Common (MARY JENNINGS)- Mary Jennings shared some updates regarding the shed at Town Field, and discussed the sheds usage with Rob Foley. Anna Eliot motioned that the Park Commission will allow space for the Trails Committee to keep equipment in the shed, Jeff Ohringer seconded, and the motion passed unanimously. Brenden Mahoney shared that the playground at Town Field has received repairs.

Woitowicz Field/ Prescott Common/ Veterans Memorial Common/Hazel Grove Park/Lawrence Memorial Playground (ANNA ELIOT)- Anna Eliot mentioned that she has received positive feedback from the community regarding the updates done at Woitowicz Field.

Badger Common/ Firemen's Common/ Legion Common/Cow Pond (JEFFREY OHRINGER)- Jeff Ohringer shared that they are waiting for the pad to be poured for the new Cow Pond shed, and that the soccer club will be paying for the entire shed.

Cutler Field/ Armstrong Memorial Common/ Lost Lake Pickleball Court/Carol Wheeler (GAIL CHALMERS)- No updates.

CPA Project Updates (ANNA ELIOT)- Mary Jennings shared that she discussed the current CPA projects with Don Black.

Park Commission Budget Review (BRENDEN MAHONEY)- Katie Berry shared accounting sheets showing invoice totals for Expense Warrant #13, as well as expenses incurred to date. Brenden Mahoney and the commissioners discussed the current funding structure and potential to restructure. The commission also discussed Mark Haddad's comments earlier in the meeting regarding the potential FY25 budget cuts.

OLD / NEW BUSINESS:

Sign permits/ invoices- Commissioners signed all invoices and permits.

Approve Minutes: Mary Jennings motioned to accept the minutes of the November 14th, 2023 Park Commission meeting as submitted, Brenden Mahoney seconded, and the motion carried, with Gail Chalmers and Jeff Ohringer abstaining.

Schedule Next Meeting and Commissioner Updates- Wednesday January 10th 5:00pm

Brenden Mahoney moved to adjourn at 3:17pm, Mary Jennings seconded, and the motion carried unanimously.

Minutes by Katie Berry.

APPROVED:

DRAFT



2022 Impact Report

NATIONAL FITNESS CAMPAIGN



CONTENTS

Message from our founder >

Issue

NFC mission and why it matters >

Campaign Status >

Campaign Impact >

NFC by the Numbers >

Highlights >

- Art Across the Campaign
- Mayors of the Campaign
- Featured Public Art
- Featured State Sponsor
- Featured Community Programming
- Featured Challenge Event

Usage >

2023 >

- Fitness Court® Studio
- Fitness Court® App



A message from our founder

We are excited about the progress we've made this year as we continue to build a wellness culture across hundreds of cities, towns and school communities. On behalf of thirteen of the largest health insurance companies in America, we are proud to make world class fitness free for everyone as an equitable offering for all. We sincerely thank our sponsors for their confidence in us and for their powerful support of our mission to increase outdoor movement in America.

We all see the costs of inactivity, the unhealthy habits born of our sedentary "car culture" and we recognize that we must do what we can to reverse a trend that we can no longer afford. Billions of dollars are being spent as a reactionary measure while life expectancy has decreased for the first time in 100 years in the United States! Unhealthy habits can and must be addressed and it all starts with actionable investment in Healthy Infrastructure.

Our work at NFC is to design the country's largest public/private partnership to redesign the built environment to create healthy communities. Working with our sponsors and partners we design Health Infrastructure to connect parks, trails, and Fitness Courts* to move people outdoors, as we work hard to increase pedestrian movement in a car centric world.

We've designed the world's best outdoor gym. The Fitness Court*, to anchor our efforts and provide access to free, world class workouts. Each outdoor Fitness Court we open delivers a full body workout, for adults of all ages and abilities, activated by a digital library of workouts that is free for all to enjoy. Each Fitness Court is a work of art – a kinetic sculpture. They are designed so communities and schools will build them in the most visible, active and connected locations. Fitness Courts* become the wellness hub for smart cities and schools of the future.

When you design the built environment to connect a city for people – with healthy hubs for active social engagement – you change the culture!

Fitness Courts* have the power to become a key connector for Healthy Communities. A Fitness Court* in a park or along a trail network, can attract meet ups and walking clubs, yoga classes, wellness clinics and so much more. Fitness Courts* are becoming a healthy social network of the wellness culture we aspire to build!

“ When you design the built environment to connect a city for people -- with healthy hubs for active social engagement -- you change the culture! ”

When our Fitness Court* network grows to reach every town, city and school in America, we will see big dreams come true as a result of the incredibly important work that our proud and powerful NFC team does every day!

Here is our 2022 Impact Report, NFC's scorecard for a monumental year of growth. For our thirteen State Sponsors and thousands of public and private partners across the country, we could not do this without you!

Please enjoy,



Mitch Managed
Founder, NFC

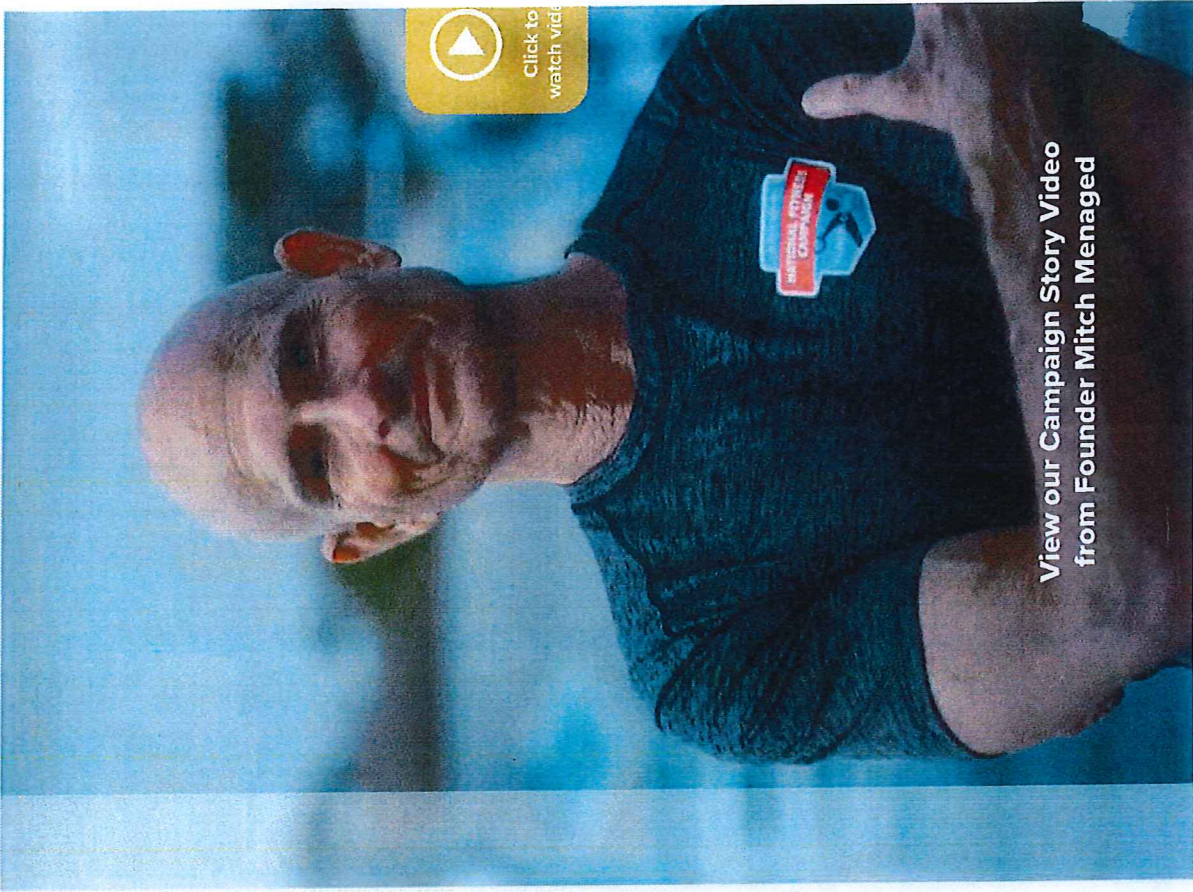

View our Campaign Story Video
from Founder Mitch Managed

WE BUILD HEALTHY COMMUNITIES

NFC Mission and Why it Matters

Problem

Nationwide Obesity

Growing rates of obesity and related diseases are killing millions every year. According to the World Health Organization, obesity has nearly tripled worldwide since 1975. Nowhere is worse than the United States, where a staggering 39.6% of adults and 18.5% of children are afflicted, according to the CDC.

Solution

Healthy Infrastructure

The momentum is growing to use the built environment to chip away at the current health crisis by expanding the number of parks and miles of trails to draw more people out of their cars. With a focus on wellness planning, NFC designs Fitness Courts as healthy hubs in parks and along trails that open pedestrian access in cities creating a lasting wellness culture.

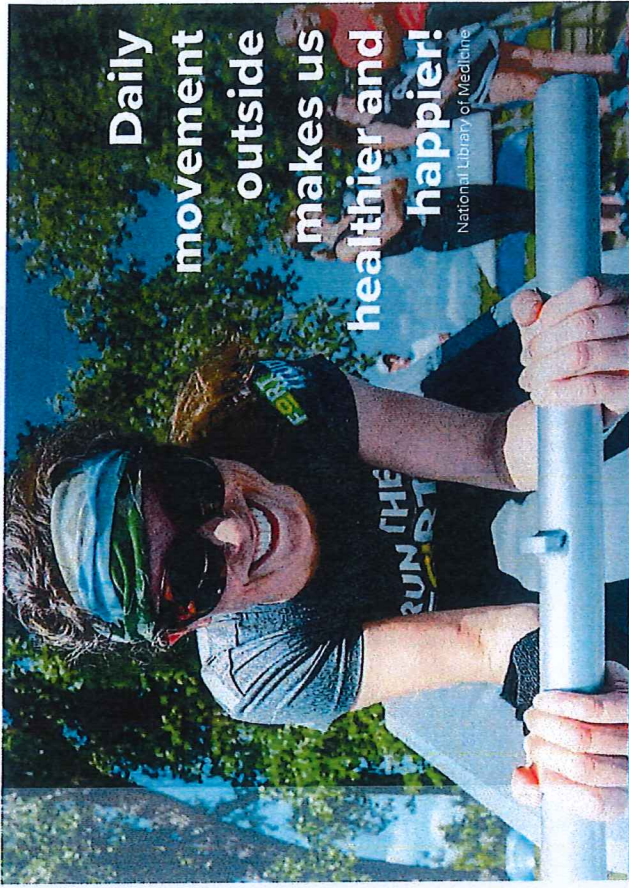

Daily movement outside makes us healthier and happier!

National Library of Medicine

Life Expectancy vs Health Expenditure

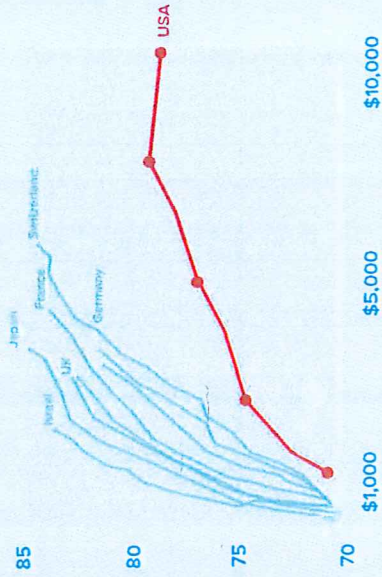

Modified chart from ourworldindata.org



Physical inactivity costs health systems \$27 billion a year, and by 2030, \$300 billion.

World Health Organization, 2022

CAMPAIGN STATUS

2023 Outlook

Over the past year, the National Fitness Campaign (NFC) State Sponsor Network has grown exponentially. NFC is thrilled to be working in concert with over a dozen of America's leading healthcare providers, now covering 25% of the states in America and representing 30 million members for a total population of 107,600,000.

These organizations represent an important group of leaders recognizing and supporting the need for our cities and schools to be places that support physical and mental wellbeing.

With the growing support from the NFC State Sponsor Network and continued interest from Mayors, Civic Officials, School Administrators, and Federal and State leaders, the Campaign will be welcoming its 500th Healthy Community in 2023, marking an important benchmark in the journey.

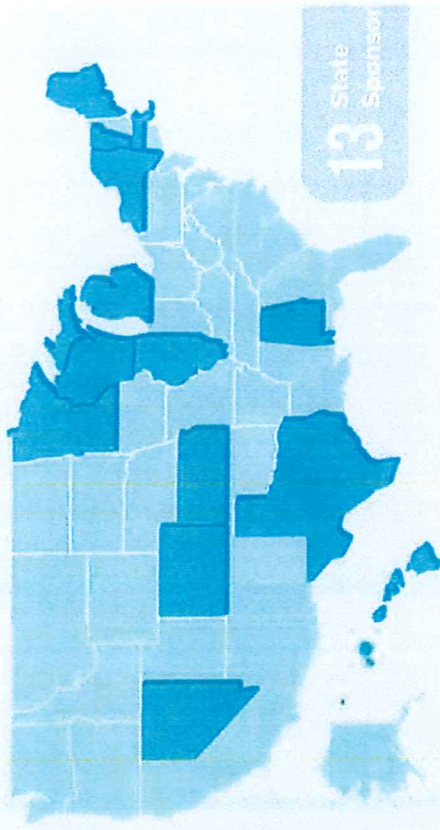

Meet the Sponsors



Build a free outdoor Fitness Court[®] within a 10 minute bike ride of every American

5,000 Fitness Courts by 2030

500TH Healthy Community in 2023



DESIGNING HEALTH IMPACT

Driving Healthy Infrastructure to Change Health in America

Everyone deserves the opportunity to be physically active, yet current infrastructure and sedentary lifestyle behaviors are a hindrance. City planners can embrace Healthy Infrastructure with proven results. When cities work with NFC planners to upgrade master plans, using Fitness Courts® as wellness hubs and anchors in active parks and visible pedestrian trails, a new Healthy Infrastructure foundation is laid to lean into healthy behavior. Site design methodology insures that Fitness Courts® will bring people outdoors and ignite walking, jogging, cycling and strength training activity. The Fitness Court® App will bring challenges and programming to millions of people who cannot afford a world class wellness system in their lives.

392

Fitness Courts
Funded

\$98 MILLION+

in public/private investment in
Healthy Infrastructure

8,790

Communities
Briefed

11,562

Civic Leaders
Engaged

3,695,500

Estimated Access by Biking
to Fitness Courts Within 10 Mins

972,500

Estimated Access by Walking
to Fitness Courts Within 10 Mins

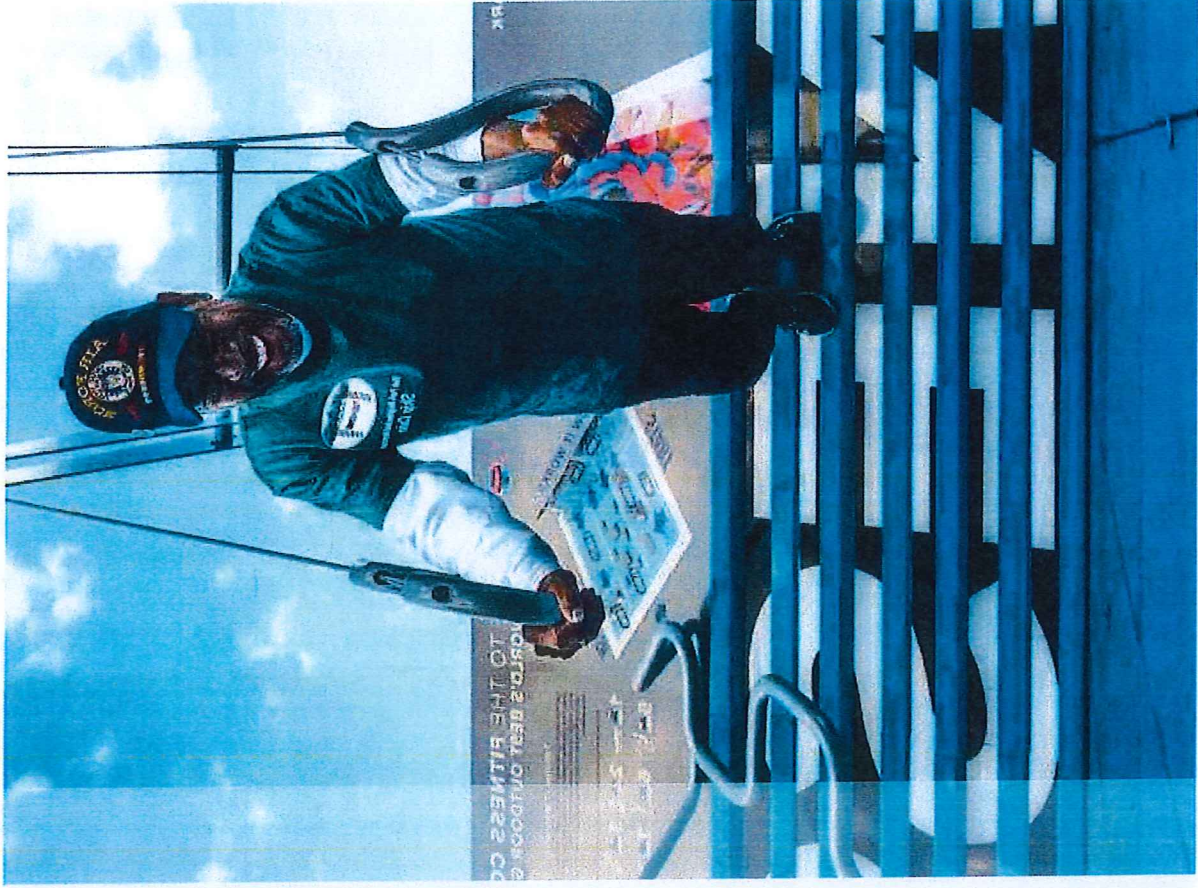

NFC BY THE NUMBERS

Partner Highlights

392

Communities joined the Campaign



553

Fitness Courts Ambassadors Trained

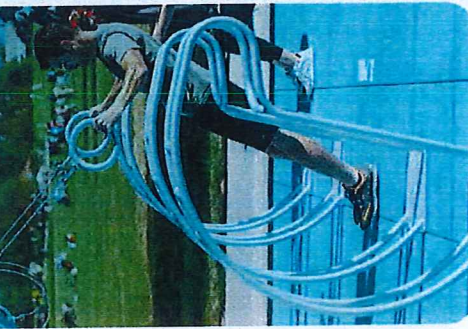

13 Fitness Courts

Largest City Network
Santa Ana, CA



815K

Largest Community Population
San Francisco, CA



545

Smallest Community Population
Jay, FL



LEADERS ACROSS AMERICA

Featured Mayors in the 2022 Campaign



PA Senator
Judy Schwank
Kutztown, PA



Fort Smith, AR
Mayor **George McGill**



Mission, TX
Mayor **Norie**
Gonzalez Garza



Santa Ana, CA
Mayor **Vicente Sarmiento**



Prichard, AL
Mayor **Jimmy Gardner**



Everett, MA
Mayor **Carlo Demaria**



NY Senator
Pamela Helming
Phelps, NY



Springfield, IL
Deputy Mayor
Guillermo Trujillo



Lewiston, ME
Mayor **Carl L. Sheline**



Newburgh, NY
Mayor **Torrence Harvey**



Grand Rapids, MI
Mayor **Rosalynn Bliss**



+400 more!

THE POWER OF ART

Building America's First Outdoor Kinetic Art Gallery

NFC is proud to offer artwork from world-renowned artists, **Keith Haring & Jean-Michel Basquiat**, as part of our Featured Artist Fitness Court™ series. The power of art opens fresh and exciting elements in a growing kinetic outdoor gallery to push deeper into motivating millions to join a new outdoor wellness culture.



Jean-Michael Basquiat Fitness Court
Fort Smith, AR

28

Artist Fitness Courts
Including works from World Renown Artist Keith Haring, Jean-Michel Basquiat and over 18 local artists from across the country.

Explore the Public Art
Gallery
[Click for More](#)

A GROWING ART GALLERY

Featured Artist Series Local Artist Series and Design Studio

Local Artist Gallery

Gene Jimenez SANTA ANA, CA	Daisy Camacho ESCONDIDO, CA	Wendy Duong SANTA ANA, CA

State Sponsor Art Gallery

--	--	--



Featured Public Art

Kutztown University, PA

Home of Artist Keith Haring

ABOUT THE ART

Berks County native, Keith Haring's art is featured on the Kutztown University Fitness Court® just a block away from his childhood home. A successful ribbon-cutting ceremony was held with attendance from Haring's family including his father and niece, along with Sen. Judy Schwank. KU students are already working to activate the Fitness Court on campus.

Keith Haring™

You don't see a lot of artworks when you go to work out in the rec or at any indoor facility. This brings a lot of energy, a lot of motivation to the Fitness Court.

KU student Morgan Hurd, a Senior Sports Management Major



Click to Read
Faculty-Student Integration at KU Fitness Court





Featured State Sponsor

MVP Health Care | NY Capital Region Press Conference

ABOUT THE PRESS CONFERENCE

MVP Health Care, SUNY Schenectady, Albany College of Pharmacy and Health Sciences, Albany County, the Cities of Albany, Schenectady, and Troy, and National Fitness Campaign (NFC) announced a partnership to bring nine outdoor Fitness Courts® to the Capital Region. The MVP Health Care Fitness Courts will provide the region with equitable access to free, high-quality workouts using state-of-the-art equipment.

This Capital Region Press Conference and Ground Breaking event brought together 3 City Mayors, 2 College Presidents, 1 Deputy County Executive and the MVP President and CEO together in one event to celebrate the commitment to Healthy Infrastructure within the NY Capital Region.

I want to thank MVP Health Care and the National Fitness Campaign for their collaboration with Capital Region municipalities and higher education institutions on this initiative that will have a real impact on the lives of countless residents.

Albany County Executive Daniel P. McCoy

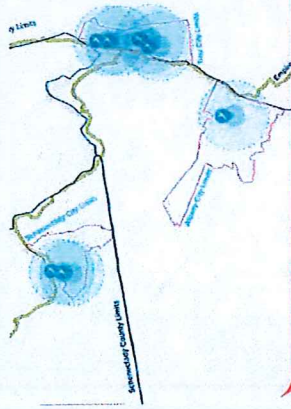

NY Capital Region Fitness Courts® in 2022





Featured Community Programming

Escondido, CA

4 Fitness Courts open out of a network of 5

ABOUT THE CITY

Over the last year the City of Escondido has cultivated a dedicated team of 5+ Fitness Court® ambassadors who have been programming a variety of classes for the community. In 2022 the team of ambassadors hosted 42 classes spread across the four open Fitness Courts®. Escondido utilizes a dedicated Facebook group to promote their classes, and build a community of people around the Fitness Court®. Currently the group consists of

500+ members and they hope to continue to increase membership. The city is excited to celebrate the opening of their fifth Fitness Court® in 2023 which will expand the access to free fitness to even more residents.

We wanted to provide an opportunity for free fitness, for families to get out and do this recreational amenity that anybody can do.

*Escondido Assistant Director of Community Services
Danielle Lopez*



Join Your Local Facebook Community





Featured Challenge Event

Local Police vs. Firefighters

ABOUT THE CHALLENGE

Over 30 Fitness Court® launches had their local city Police and Fire Departments participate and compete head to head in the Battle of the Badges Fitness Court® Challenge in 2022.

Various cities are continuing the fun with ongoing free to the public Fitness Court® classes lead by civic service leaders though out the year.



Click for Example Video Link

Race to the Ribbon Video Link

32

Police & Fire Department Challenges in 2022

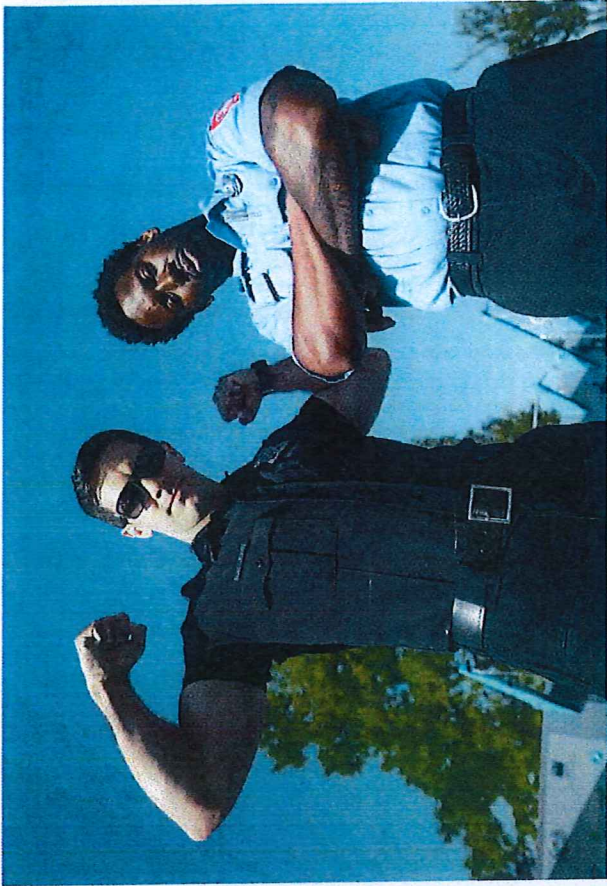

CHANGING LIVES

Ambassador Testimonials and Story Highlights



AMBASSADOR

West Allis, WI

I started hosting these free workouts for the West Allis community in 2021 because I know fitness can be overwhelming, expensive, and not enjoyable for some people. And we solve all these issues at the fitness court workouts!

Laura Heddon
Laura started a Facebook group and has hosted over 20 free workouts at the West Allis Fitness Court* with more than 100 different community members in attendance.



PROJECT 50

Foster City, CA

Consistency over time is key.

In 2022, @lando.cbr went on a 50 day fitness challenge to complete a workout each day. His local Fitness Court* in Foster City helped him achieve this goal. The Fitness Court allowed him to complete a balance, cardio and strength training workout.



CHALLENGE

Inspiration Award

Thankful and excited for what the Fitness Court offers to my community... Its very motivational being able to train and exercise OUTSIDE while helping my community take their Fitness to the NEXT LEVEL!!!

Thomas (mrnextlevelfitness)
Inspires all of us to take it to the next level. Participated in NFC's 2022 My Favorite Fitness Court* Challenge and received the Inspiration Award.





Fitness Court Studio

Launching Nationwide 2023

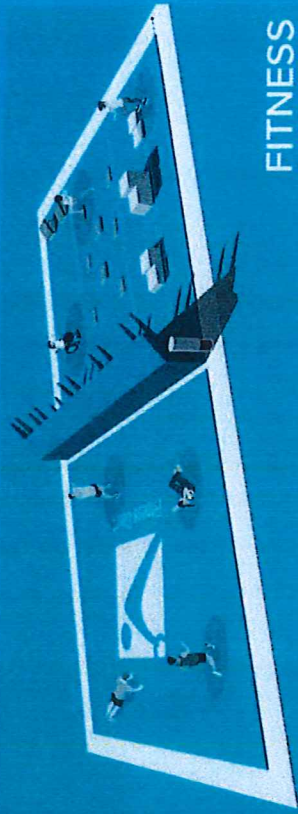

- FITNESS
- ART
- DANCE
- YOGA
- ZUMBA
- PILATES
- STRETCH



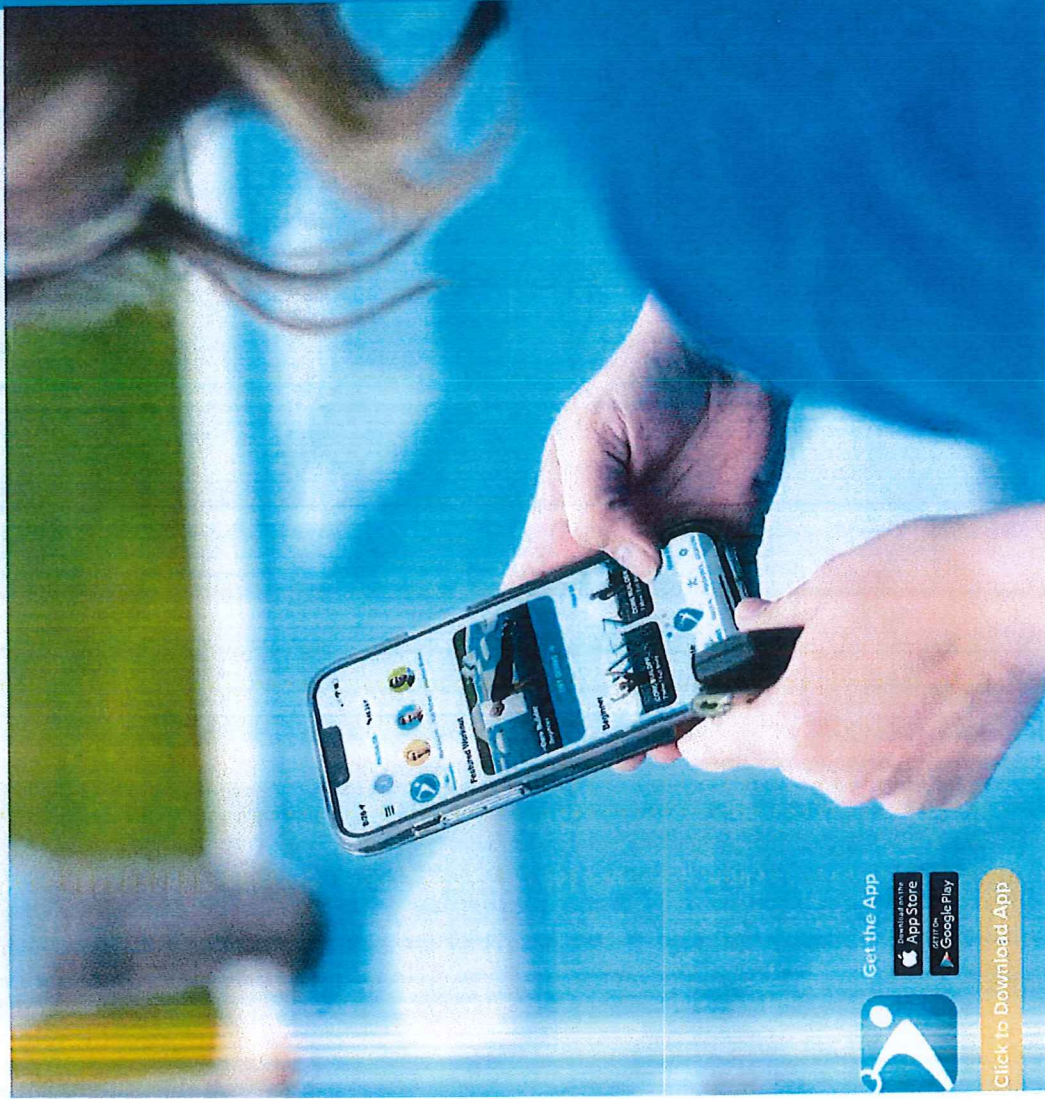

Get the App



Click to Download App

Fitness Court® App

Launching Nationwide 2023

Digitally Connected Fitness Court

Every Fitness Court will be digitally connected to a robust library of workouts challenges and health kit metrics by the free Fitness Court App. With a new interactive map, you'll be able to find every Fitness Court location at the palm of your hand! Soon millions of people will have access to the worlds-best outdoor gym and a system that is designed to move people outside everyday. Walking and moving to healthy hubs, social connections will build new friendships and wellness habits. The Fitness Court App aims to build a healthy nation of active members, solo or in groups, staying fit anytime of the day and enjoying the worlds largest network of digital Fitness Courts teaching and coaching adults young and old everywhere.

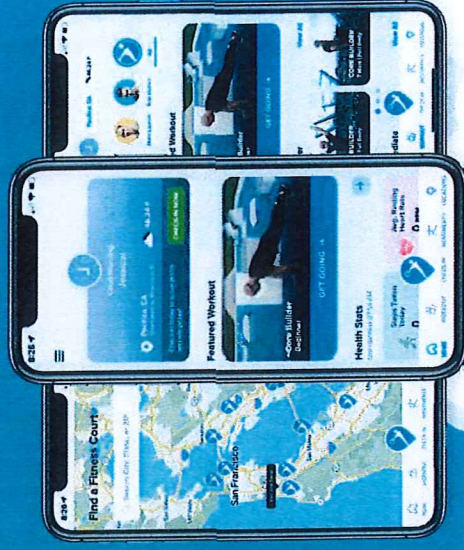

APPLE HEALTH CONNECTION • NEW WORKOUT CONTENT
• CHECK-IN CHALLENGES • LOCATION MAP

FOR FUN!

World Class Dance Group Pilobolus Takes on the Fitness Court®!

[Click to watch full performance](#)



Click to watch video

ABOUT PILOBOLUS

Pilobolus is a rebellious dance company. Since 1971, Pilobolus has tested the limits of human physicality to explore the beauty and the power of connected bodies. They bring our decades of expertise telling stories with the human form to show diverse communities, brands, and organizations how to maximize group creativity, solve problems, create surprise, and generate joy through the power of nonverbal communication.

Pilobolus has created and toured over 120 pieces of repertory to more than 65 countries. They currently perform their work for over 300,000 people across the U.S. and around the world each year. In the last year, Pilobolus was featured on The Late Show with Stephen Colbert, NBC's TODAY Show, MTV Video Music Awards, The Harry Connick Show, ABC's The Chew, and the CW Network's Penn & Teller: Fool Us. Pilobolus has been recognized with many prestigious honors, including a TED Fellowship, a 2012 Grammy Award Nomination, a Primetime Emmy Award for Outstanding Achievement in Cultural Programming, and several Cannes Lion Awards at the International Festival of Creativity in 2015. Pilobolus was named one of Dance Heritage Coalition's "Irreplaceable Dance Treasures." Pilobolus has collaborated with more than 75 brands and organizations in finance, retail, media, fashion, and health. Visit [www.pilobolus.com](#), [facebook.com/pilobolus](#), [twitter.com/pilobolus](#), and [instagram.com/pilobolus](#).





National Fitness Campaign

San Francisco, CA

(415) 702-4919
info@ntfcq.com



Visit
nationalfitnesscampaign.com



NATIONAL FITNESS CAMPAIGN

SAN FRANCISCO, CA

DATE: 3/9/2022
BY: MAXIMUS INNOVATIONS
NAME: TILE SLAB
REV: 7.2 PAGE 1/4

ANCHOR BILL OF MATERIAL			
ITEM	QTY	DESCRIPTION	NOTES
ANCHOR A	30	WALL ANCHOR	SEE ANCHOR DETAILS
ANCHOR B	28	DROP-IN ANCHOR	SEE ANCHOR DETAILS
ANCHOR C	48	MECHANICAL ANCHOR	SEE ANCHOR DETAILS
ANCHOR EPOXY	AS REQD	HILTI HIT-HY 200 FOR WALL ANCHORS (SEE ANCHOR DETAILS RE: ALTERNATE EPOXY)	SEE ANCHOR DETAILS

SLAB NOTES

(FOR FLAT TOP SLAB / TILE FLOOR INSTALLATION)

NOTES:

- ALL SLAB CONCRETE TO BE 4,000 PSI AT 28 DAYS (CONCRETE STRENGTH REQUIREMENT). A HIGH EARLY MIX MAY BE UTILIZED ONLY IF THE MIX DESIGN IS APPROVED BY THE ENGINEER. CEMENT SHALL CONFORM TO ASTM C 150, TYPE II.
- FINE AGGREGATE SHALL CONFORM TO ASTM C 33.
- COARSE AGGREGATE SHALL BE GRAVEL OR CRUSHED STONE CONFORMING TO ASTM C 33. COARSE AGGREGATE FOR FLOOR SLAB SHALL NOT EXCEED 1/4" AT ITS MAXIMUM WIDTH.
- WATERS SHALL BE CLEAN AND FREE FROM INHIBITORS, AMOUNTS OF OILS, ACIDS, ALKALIES, ORGANIC MATERIALS OR DELETERIOUS SUBSTANCES.
- AIR ENTRAINING ADJUSTMENTS SHALL CONFORM TO ASTM C 266.
- CALCIUM CHLORIDE ADJUSTMENTS, THROMBATE ADJUSTMENTS OR ANY ADJUSTMENTS CONTAINING MORE THAN 0.5% CHLORIDE IONS ARE NOT PERMITTED.
- REINFORCING STEEL AND CONCRETE TO BE PLACED IN ACCORDANCE WITH ACI 318 LATEST EDITION.
- THE ALLOWABLE CONCRETE SLUMP SHALL BE 3" PLUS OR MINUS 1/2", UNLESS SUPERPLASTICIZERS ARE USED. THE ENGINEER SHALL APPROVE SUPERPLASTICIZER USE.
- AS REQUIRED BY OWNER, SLUMP TEST SHALL BE MADE IN ACCORDANCE WITH ASTM C 143.
- NO CONCRETE SHALL BE PLACED WHEN THE ATMOSPHERIC TEMPERATURE IS BELOW 40° F WITHOUT PERMISSION OF THE ENGINEER.
- THE ENGINEER OR THE OWNER MAY ACCEPT OR REJECT ANY WORK THAT DOES NOT MEET THE REQUIREMENTS OF THESE NOTES OR THE PROJECT DRAWINGS.
- AS REQUIRED BY OWNER, CONTRACTOR SHALL MAKE ARRANGEMENTS FOR TESTING THE SLUMP, AIR CONTENT, AND CONCRETE CYLINDERS.
- AS REQUIRED BY OWNER, COMPRESSIVE STRENGTH OF THE CONCRETE CYLINDERS SHALL BE TESTED AT 3 DAYS, 7 DAYS AND 28 DAYS. APPROPRIATE NUMBER OF CYLINDERS SHALL BE COLLECTED TO PERFORM THE TESTING. CYLINDERS SHALL BE TESTED IN ACCORDANCE WITH ASTM C 39.
- SLAB TO BE Poured IN EITHER 20 FT X 20 FT SECTIONS (MAX) OR PROVIDE 1/2" SAW CUT CONTRACTION JOINTS AT 20 FT MAXIMUM SPACING. SAW CUT JOINTS TO BE MADE AS SOON AS THE CONCRETE HAS CURED SUFFICIENTLY TO ALLOW THE WORK WITHOUT DAMAGING THE CONCRETE.
- CONFORM ANCHOR PLACEMENT PRIOR TO CUTTING JOINTS. ENSURE 3" CLEARANCE BETWEEN ANCHOR CENTERS AND JOINT AND CUT JOINTS AS SHOWN ON PLAN VIEW.
- PROVIDE 4" TO 6" OF CRUSHER RUN GRAVEL AS SHOWN IN SECTION DETAIL.
- SOIL TO BE COMPACTED TO MEET THE REQUIREMENTS OF 95% MODIFIED PROCTOR.

INSTALLATION SEQUENCE

(FOR FLAT TOP SLAB / TILE FLOOR INSTALLATION)

- REVIEW ALL DRAWINGS INCLUDING ALL NOTES TO BECOME FAMILIAR WITH SEQUENCE AND DETAILS.
- DURING INSTALLATION SEQUENCE, REFER TO AND COMPLY WITH APPLICABLE NOTES.
- PREPARE AREA BELOW SLAB WITH COMPACTED SOIL AND GRAVEL PER PREP SECTION DETAIL VIEW ON REINFORCEMENT / PREP DETAIL DRAWINGS.
- BUILD FORMS FOR OUTER PERIMETER OF THE SLAB WITH DIMENSIONS PER SLAB PLAN AND SELECTED WIDTH OF OUTER BAND AROUND FITNESS COURT AREA.
- INSTALL REINFORCEMENT STEEL PER THE REINFORCEMENT / PREP DETAIL DRAWING.
- PLACE SPECIFIED CONCRETE PER THICKNESS SHOWN IN SECTION A-A OF CONCRETE SLAB PLAN & CROSS-SECTION DRAWING.
- FINISH CONCRETE TO THE SLOPE SPECIFIED FOR DRAINAGE.
- TILE FLOOR SHOULD BE INSTALLED PRIOR TO INSTALLING ANCHORS IN THE TILE FLOOR AREA.
- ANCHOR LOCATIONS PER WALL ANCHOR LOCATIONS DRAWING AND FLOOR ANCHOR LOCATIONS DRAWING AS SHOWN IN THE FITNESS COURT INSTALLATION INSTRUCTIONS.
- ANCHOR LOCATION DIMENSIONS ARE ORDINATE DIMENSIONS MEASURED FROM THE UPPER LEFT CORNER OF THE TILE FLOOR. CONFIRM CORRECT DIMENSIONS ARE USED FOR PLACING ANCHORS.
- REFER TO ANCHOR DETAILS FOR TILE DRAWING FOR ANCHOR DRILLING DIAMETER AND DEPTH.
- NOTE: WHEN DRILLING HOLES FOR ANCHORS, MAKE SURE THE HAMMER DRILL IS VERTICAL.
- DRILL HOLES IN TILE AND IN CONCRETE FOR ANCHORS USING THE METHOD(S) AS OUTLINED IN THE FITNESS COURT INSTALLATION INSTRUCTIONS FOR HOLE PLACEMENT.
- NOTE: PLYWOOD AND BAND STATION TEMPLATES WILL REQUIRE REUSE TO LOCATE ALL ANCHORS. REFER TO TEMPLATE NOTES IN THE FITNESS COURT INSTALLATION INSTRUCTIONS FOR DETAILS OF SUPPLIED TEMPLATES.
- INSTALL EPOXY ANCHORS TO THE DEPTH INDICATED UTILIZING THE SPECIFIED EPOXY AND THE MANUFACTURER'S EPOXY INSTALLATION INSTRUCTIONS.
- INSTALL MECHANICAL ANCHORS TO THE DEPTH INDICATED. BE CAREFUL TO AVOID INSTALLING ANCHORS TOO DEEP FOR THE BEND STATIONS.

REINFORCEMENT

- INSTALL SLAB REINFORCING 6 X 6 X 9/8 WELDED WIRE MESH (WWM) PLACED IN THE CENTER OF THE SLAB TO EXTEND THROUGH ENTIRE SLAB. UTILIZE SUFFICIENT NUMBER OF CHAIRS TO MAINTAIN WWM POSITION.
- INSTALL ADDITIONAL / UPGRADED REINFORCEMENT AS REQUIRED BY LOCAL CODE.
- REINFORCING TO BE NEW BILLET STEEL MEETING THE REQUIREMENTS OF ASTM A618 GRADE 60.
- PROVIDE VAPOR BARRIER BELOW THE SLAB AS REQUIRED BY LOCAL CODE AND CONDITIONS.

CONCRETE FINISHING NOTES:

- THE FINISHED CONCRETE SURFACE SHOULD BE SLOPED AWAY FROM THE WALL. THE SURFACE SLOPE SHOULD BE 1/8" PER 12".
- SHOULD BE FLAT TO THE EQUIVARIANT OF 3/16" OVER 10'.
- THE FINISHED CONCRETE SURFACE SHOULD HAVE A LIGHT BROOM FINISH TO PROVIDE THE BEST SURFACE FOR COURT SURFACE ADHESION.
- IMPORTANT: FLOORING INSTALLATIONS REQUIRE A 28 DAY CURE TIME AFTER CONCRETE PLACEMENT. FLOORING INSTALLATIONS CAN BE ACCELERATED WITH AN APPLICATION OF SPRAYLOCK PRODUCT. SPR-32 OR EQUIVARIANT IS REQUIRED. THE SPRAYLOCK PRODUCT WILL ALLOW FLOORING INSTALLATION AS SOON AS 14 DAYS AFTER CONCRETE PLACEMENT AND SPRAYLOCK APPLICATION. CONFIRM PRODUCT SELECTION WITH THE MANUFACTURER. APPLY SPRAYLOCK PRODUCT THE DAY OF THE CONCRETE PLACEMENT PER MANUFACTURER'S INSTRUCTIONS.

ANCHOR NOTES:

- FIELD VERIFY ALL ANCHOR LOCATION DIMENSIONS AND PATTERNS PRIOR TO DRILLING. SEE FITNESS COURT INSTALLATION INSTRUCTIONS FOR ANCHOR LOCATIONS.
- DRILL THROUGH TILE FLOOR (1" TILE THICKNESS) WHERE NECESSARY WITH APPROPRIATE DRILL BIT TO MATCH ANCHOR HOLE IN CONCRETE.
- SEE ANCHOR DETAILS FOR APPLICABLE CONCRETE EMBEDMENT DEPTH AND HOLE DIAMETER.
- STAINLESS STEEL MUST BE USED WHERE SPECIFIED.
- COMPONENTS SPECIFIED AS HOT-DIP GALVANIZED MAY BE SUBSTITUTED WITH 304 SS COMPONENTS.
- WHEN INSTALLING ANCHORS, TAKE CARE TO USE THREAD PROTECTORS TO PREVENT THREAD DAMAGE.

GENERAL

- SITE PREPARATION REQUIREMENTS AND CONCRETE SLAB DESIGN SHOULD BE REVIEWED BY LOCAL CIVIL OR SOILS ENGINEER TO CONFIRM SUITABILITY BASED UPON SITE SPECIFIC NEEDS AND CONDITIONS.

THIS DOCUMENT IS PROPERTY OF MFC (THE NATIONAL FITNESS CAMPAIGN). THIS DOCUMENT CONTAINS CONFIDENTIAL AND PROPRIETARY INFORMATION AND MAY ONLY BE USED BY PERMISSION FROM MFC AND FOR THE PURPOSES AND CHANNELS AUTHORIZED BY MFC. DISSEMINATION OR OTHER USE OF THIS DOCUMENT IS NOT PERMITTED WITHOUT THE PRIOR WRITTEN PERMISSION OF MFC.

CONCRETE SLAB PLAN & CROSS-SECTION (FOR FLAT TOP SLAB / TILE FLOOR INSTALLATION)

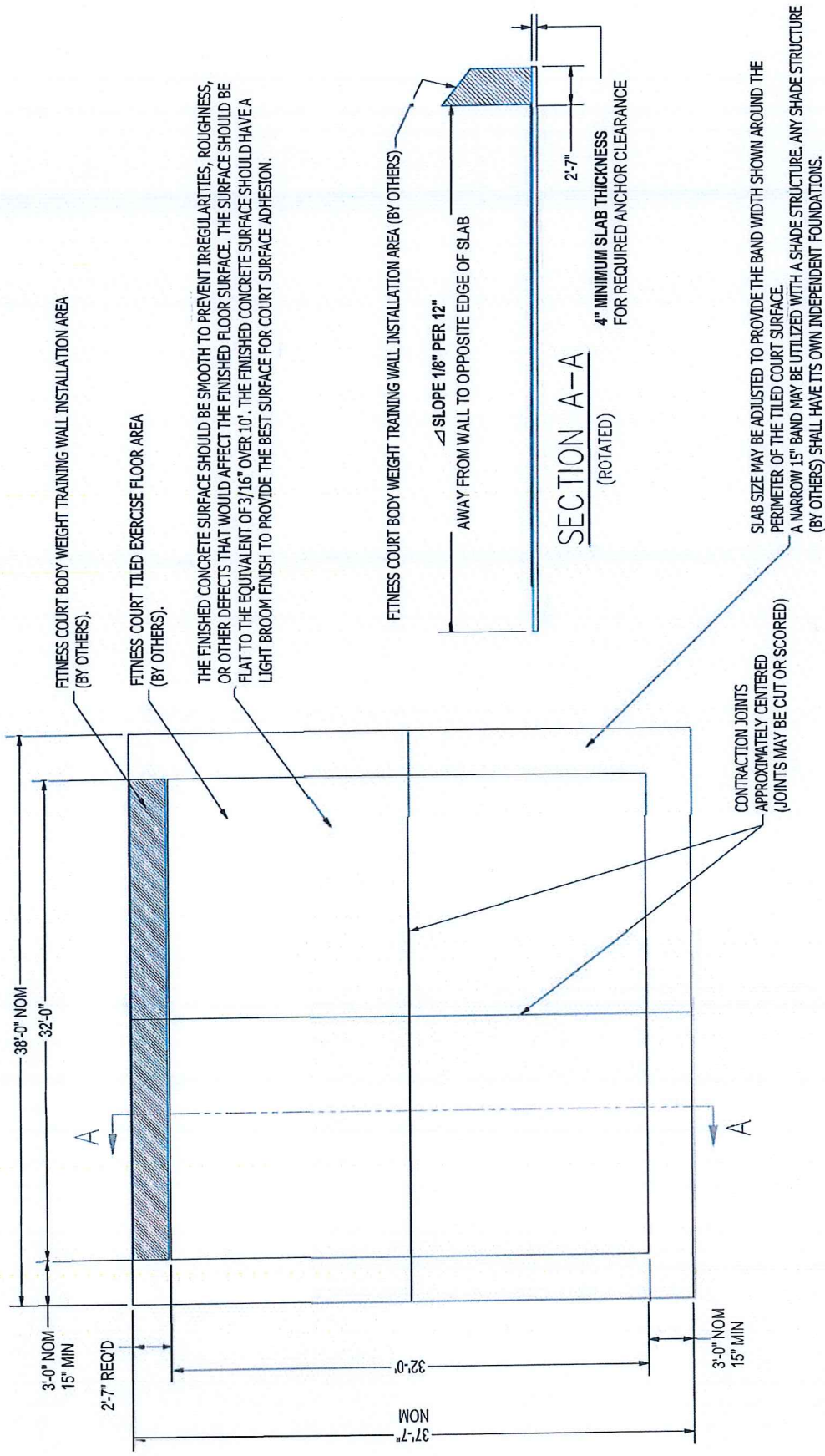

THIS DOCUMENT IS PROPERTY OF NFC (THE NATIONAL FITNESS CAMPAIGN). THIS DOCUMENT CONTAINS CONFIDENTIAL AND PROPRIETARY INFORMATION AND MAY ONLY BE USED BY PERMISSION FROM NFC AND FOR THE PURPOSES AUTHORIZED BY NFC. DISCLOSURE, DUPLICATION, MODIFICATION, OR OTHER USE OF THIS DOCUMENT IS NOT PERMITTED WITHOUT THE PRIOR WRITTEN PERMISSION OF NFC.

REINFORCEMENT / PREP DETAIL (FOR FLAT TOP SLAB / TILE FLOOR INSTALLATION)

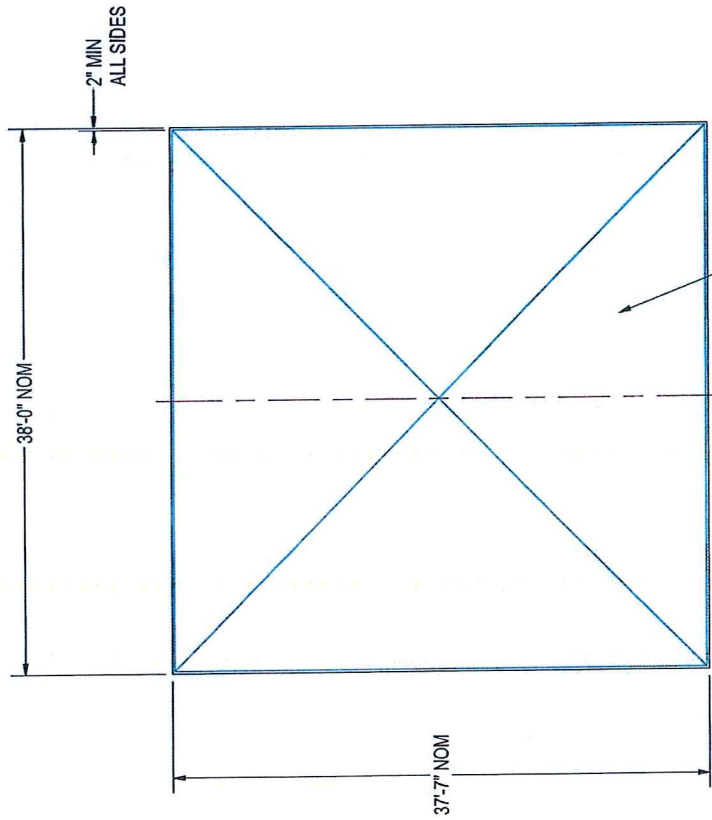

REINFORCING TO BE 6 X 6 WELDED WIRE MESH (WWM) PLACED IN THE CENTER OF THE SLAB TO EXTEND THROUGH ENTIRE SLAB. UTILIZE SUFFICIENT NUMBER OF CHAIRS TO MAINTAIN WWM POSITION. INSTALL ADDITIONAL REINFORCEMENT AS REQUIRED BY LOCAL CODE.

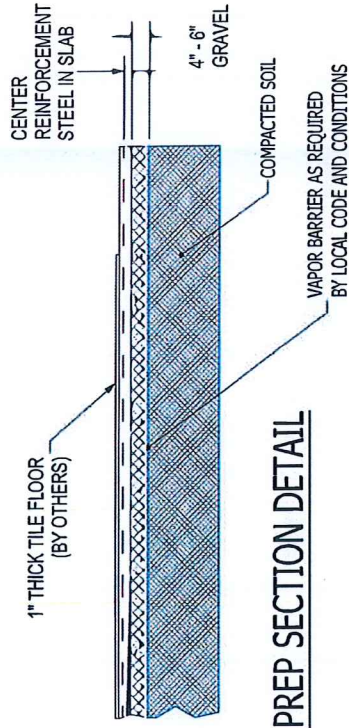

PREP SECTION DETAIL

ANCHOR DETAILS FOR TILE

APPLIES TO TILE INSTALLATION ONLY.
REQUEST ALTERNATE DRAWING FOR FOUR-IN-PLACE.
(ALSO SEE ANCHOR NOTES ON SLAB NOTES DRAWING)

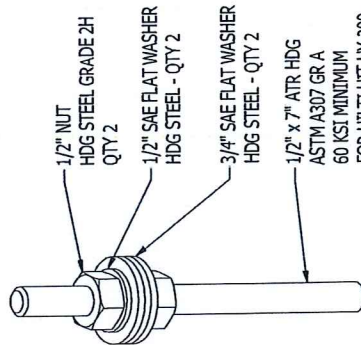
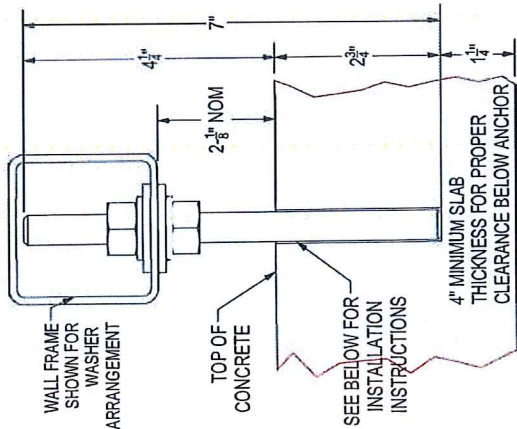

ANCHOR A
WALL ANCHOR
DRILL 9/16" HOLE IN CONCRETE FOR 2-3/4" EMBEDMENT

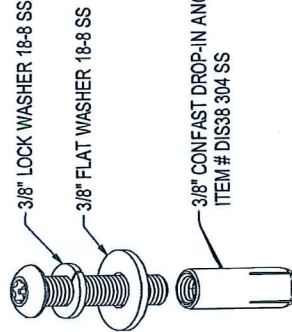
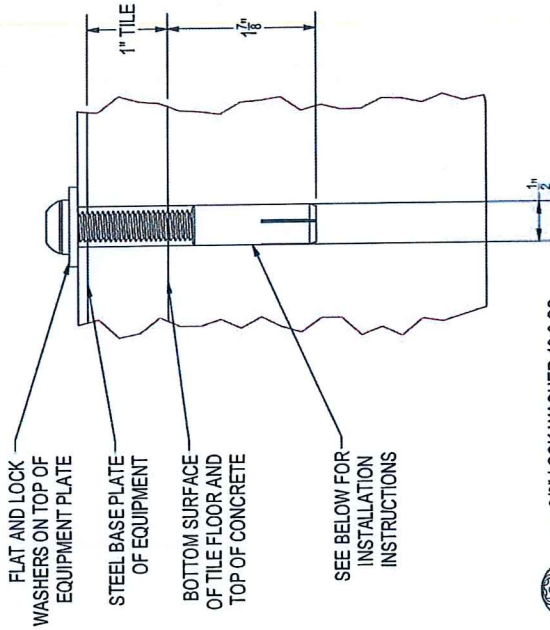

ANCHOR B
DROP-IN ANCHOR
DRILL 1/2" HOLE IN CONCRETE FOR 1 - 9/16" EMBEDMENT

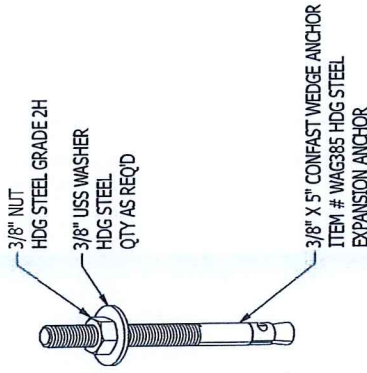
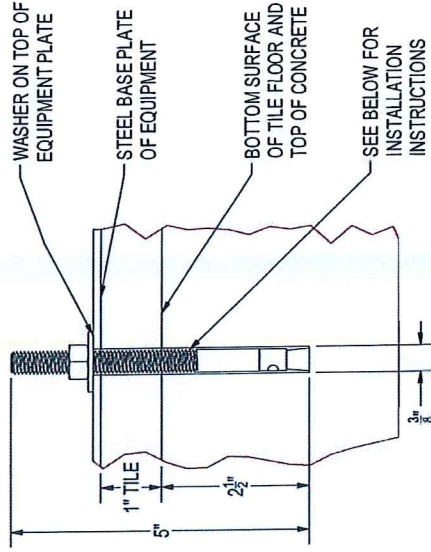

ANCHOR C
MECHANICAL ANCHOR
DRILL 3/8" HOLE IN CONCRETE FOR 2-1/2" EMBEDMENT

- ANCHOR HOLE INSTRUCTIONS**
1. DRILL HOLES FOR ANCHORS TO SPECIFIED DIAMETER AND DEPTH
 2. USE COMPRESSED AIR TO REMOVE CONCRETE DUST AND DEBRIS FROM HOLES PRIOR TO ANCHOR INSTALLATION
 3. REFER TO FITNESS COURT INSTALLATION INSTRUCTIONS FOR ADDITIONAL ANCHOR INSTALLATION STEPS

ANCHOR A EPOXY NOTE:
ANCHOR A MUST BE INSTALLED WITH THE ANCHOR EPOXY SPECIFIED OR ACCEPTABLE ALTERNATIVE. HILTI HY-200 IS RECOMMENDED. ALTERNATE EPOXY SIMPSON SET-XP IS ACCEPTABLE FOR NEW UNCRACKED CONCRETE ONLY. ALTERNATE EPOXY SIKKA ANCHORFIX-2 IS ACCEPTABLE FOR NEW, UNCRACKED CONCRETE ONLY. FOLLOW EPOXY MANUFACTURER'S INSTALLATION PROCEDURES.

THIS DOCUMENT IS PROPERTY OF NFC (THE NATIONAL FITNESS CAMPAIGN). THIS DOCUMENT CONTAINS CONFIDENTIAL AND PROPRIETARY INFORMATION AND MAY ONLY BE USED BY PERMISSION FROM NFC AND FOR THE PURPOSES AUTHORIZED BY NFC. DISCLOSURE, DUPLICATION, MODIFICATION, OR OTHER USE OF THIS DOCUMENT IS NOT PERMITTED WITHOUT THE PRIOR WRITTEN PERMISSION OF NFC.





Fitness Court® Accessibility Overview

A Community Platform For All



Design DNA

The Fitness Court® is a comprehensive functional fitness circuit training facility. It includes an endless variety of training methods for adults of all ages and skill levels. The 7 Minute 7 Movement circuit training is designed specifically for the Fitness Court to provide a full body workout for all levels and leverages your body weight so you can improve over time. The Fitness Court® is 38'x38' in size and is roughly half the size of a standard tennis court. The design is the exact same in every location to ensure quality and usability for all.

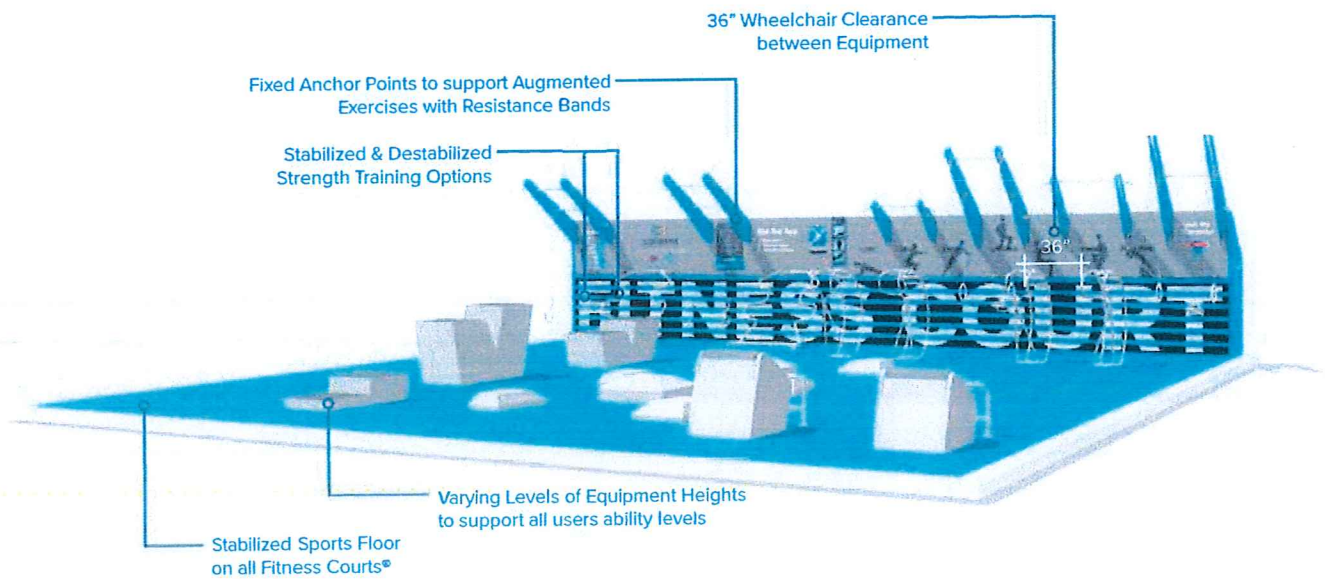

Sports Floor

Every single Fitness Court® is required to have a continuous fully accessible sports floor that is easy to navigate and allows ease of wheelchairs, walkers, strollers and other assistance devices.

36" Clearance

The Fitness Court® was designed to allow a 30" path throughout the whole system & elements allowing proper wheel chair accessibility though out.

Multi-Station

Each zone on the Fitness Court® is multi-station to allow users to utilize the same equipment & workouts with friends or spotters at the same time. It is important to NFC that the entire community is able to access the Fitness Court® and participate side-by-side.



Fitness Court® Accessibility Overview

A Community Platform For All

Adults of All Ages & Ability Levels

The Fitness Court® is designed for adults of all ages and accommodates a variety of skill levels and abilities at each station, from beginner to expert. Each station allows users to leverage their bodyweight at different angles and levels of resistance as a tool to improve over time. The Fitness Court® is a powerful way to encourage physical activity and promote community wellness.

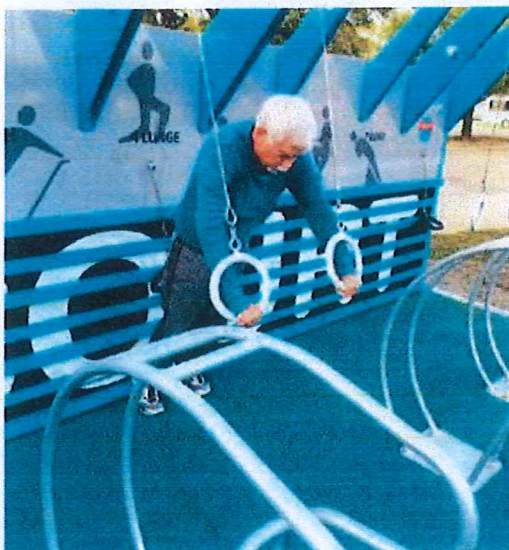

Progressive Foot Hold Strips Allow User to Leverage Body Weight and Progress Over Time



Fixed Anchor Points Support Augmented Exercises with Resistance Bands



Fit for Adults of All Ages and Ability Levels

Endless Variations & Activation

The Fitness Court supports progressive functional fitness for senior adults. Each of the seven basic movements supports activities of daily living, and each station provides users hundreds of different ways to leverage their own bodyweight for sustained health. This unique outdoor gym is a safe and effective tool for seniors to increase balance, encourage mobility, and reduce risk of injury. When integrated into a regular wellness practice, the Fitness Court supports core health, hip and joint flexibility, upper body strength and lower back stability.



Wheelchair Access at Destabilized Pull Rings



Wheelchair Access at Stabilized Pull Ladder



Wheelchair Access at Destabilized Pull Rings



Fitness Court® Accessibility Overview

A Community Platform For All

Engagement on the Fitness Court

NFC provides various opportunities to increase engagement on the Fitness Court®. Through the Ambassador program cities have the ability to run targeted classes and training for all ages and abilities. Classes ranging from Mobility and Balance series to 60+/Silver Sneakers programs have been help on the Fitness Court®. NFC supplies your community with training and annual routines and allows the local community to hold classes that are gear towards your specific user groups.



Balance Series
Tone the mind and body in a beautiful outdoor setting

Mobility Series
Maintain and restore joint health and range of motion



Challenge Series
Friendly competition for active adults in 3, 5 or 7 minute intervals

I'm encouraged, and glad to see the outdoor Fitness Court includes equipment to improve balance, which is key to preventing falls. It's free and open to the public, so no one would have any reason not to take advantage of it."

-Carol Claybaker, Senior Resident of Janesville, WI

The Fitness Court® App

The Fitness Court® App is your digital gateway to the ecosystem and your personal coach in your pocket. Learn the moves at varying levels and understand the 7 Minute-7 Movement rotation. Moves can be adjusted as needed for ability levels. New workouts from world renowned trainers constantly updated to the app showcasing specialized routines like the Mobility & Balance and Mobility Flow.

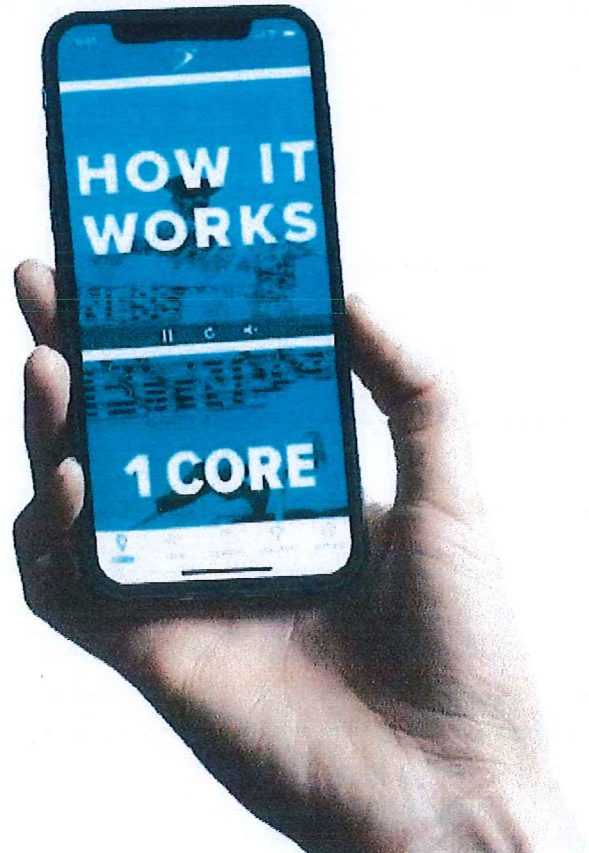
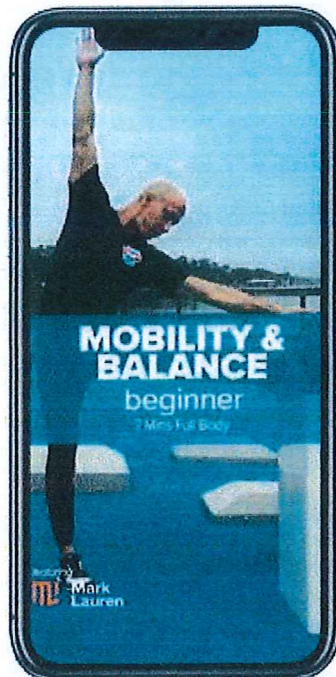



Fitness Court® Accessibility Overview

A Community Platform For All

Fitness Court® Equipment Layout

ADA Fitness Court® equipment layout allowing wheelchair accessibility and clearance for other stability assistance equipment.

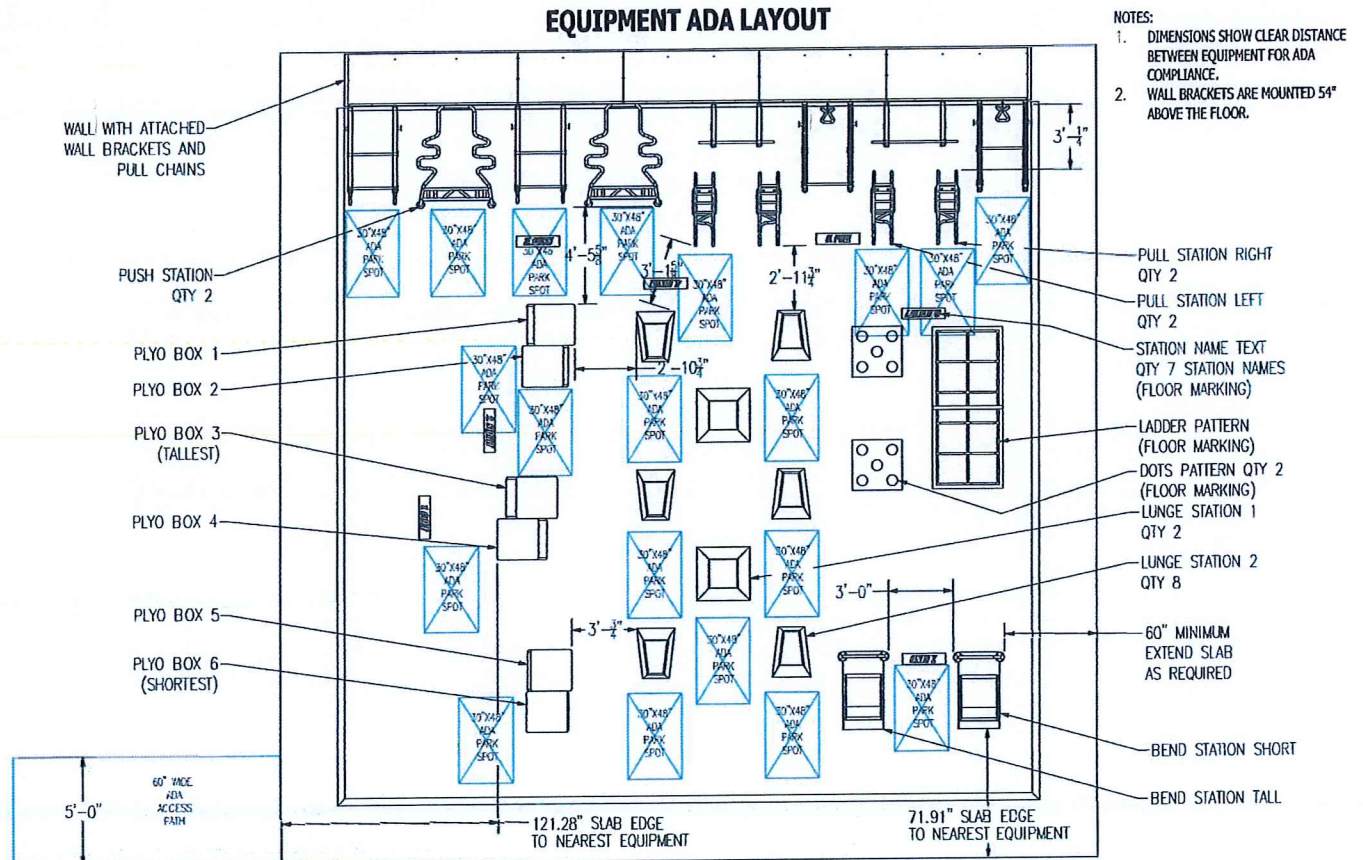

THIS DOCUMENT IS PROPERTY OF NFC (THE NATIONAL FITNESS CAMPAIGN). THIS DOCUMENT CONTAINS CONFIDENTIAL AND PROPRIETARY INFORMATION AND MAY ONLY BE USED BY PERMISSION FROM NFC AND FOR THE PURPOSES AUTHORIZED BY NFC. DISCLOSURE, REPRODUCTION, MODIFICATION, OR OTHER USE OF THIS DOCUMENT IS NOT PERMITTED WITHOUT THE PRIOR WRITTEN PERMISSION OF NFC.



NFC APPROVED INSTALLATION NETWORK



Baylor University

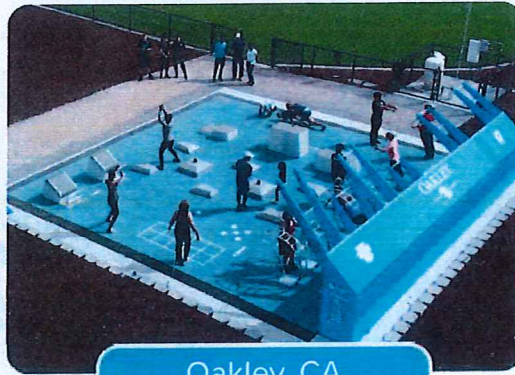

Oakley, CA



Oregon, OH

**Guaranteed Completion in
4 Days or Less** *(weather permitting)*

Competitive Flat Rate
Travel Expenses Included

All Flooring Labor Included

All Vinyl Artwork Install Included

Once the concrete slab is poured, NFC's Approved Installation Network is your all-in-one support for the installation of the sports floor, Fitness Court body-weight training wall, and equipment elements. With various installations all over the country, NFC's network of Approved Installers is the #1 recommended option.

**NFC Approved Installation Team contracted separately from NFC.*

Las Vegas, NV

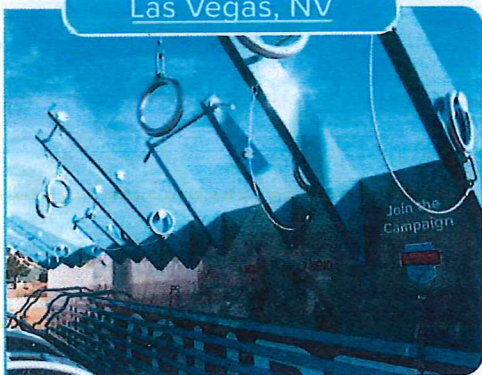

CU Boulder

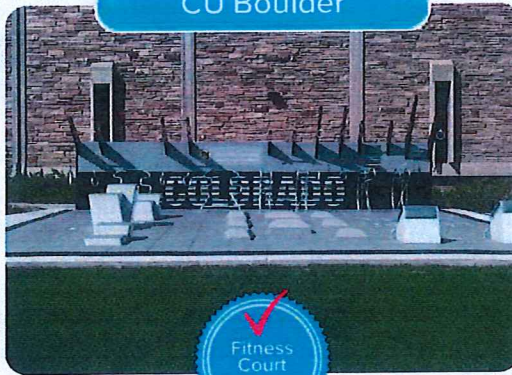

Florida State Univ.

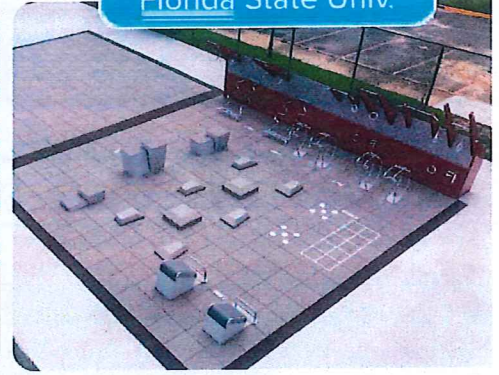

NFC is proud to partner with an approved network of installation teams, now available for Fitness Court® installations across the country!



NFC's Approved Installation Network are Fitness Court® Experts

NFC's Approved Installation Network has comprehensive knowledge of the Fitness Court®. NFC's Approved Installers have the experience to make your installation easy and predictable. The approved install team will work with you to uncover all the potential obstacles prior to the installation, will schedule the installation to meet your needs and will certify the installation is complete per NFC Installation Instructions. You will not find another network of installation teams who will provide the same level of value and quality.

The Fitness Court® - Installation Specifications

Approved National Fitness Campaign Fitness Court® installers are secured through NFC's approved network.

The following items are **Included** in the Fitness Court® Installation:

- Sports Tile Floor
- Body-weight Training Wall
- Equipment Elements
- Anchor Bolts
- Floor Marking Painting
- Sign Wall Graphics
- Signed Certificate of Completed Installation (includes walk-through with Owner / Client)

The following items are **Not Included** in the Installation

- Concrete slab built & cured, according to provided slab drawing specification.
- Procurement / supply of The Fitness Court®, Fitness Court® Tile, and Fitness Court® Installation Kit.

Items to Coordinate with Owner / Client Prior to Installation

- Delivery of the Fitness Court® material
- Security of the site (fence or barrier)
- Plan for debris & trash removal

Fitness Court Warranty

- Warranty ratified upon receipt of Signed Certificate of Completed Installation

Supporting Documentation - *provided by NFC*

- NFC provided concrete slab drawings
- The Fitness Court® Tile overview
- The Fitness Court® Specifications
- The Fitness Court® Installation Kit overview
- The Fitness Court® Installation and Maintenance Manual
- The Fitness Court® Vinyl Artwork Alignment Guide

Total Funding Requirement: \$25,000.00

Total Funding Requirement with Prevailing Wage: \$27,000.00

STEP 3

2024 CAMPAIGN FUNDING REQUIREMENT

NFC PROGRAM FUNDING

The Fitness Court® Studio and National Campaign Services

\$ 195,000



National Fitness Campaign Grant Award

(\$30,000 - \$50,000)

Fitness Court® Studio Art Options: (note: powder-coating color and included art design dependent on state sponsor)



Design Studio Standard Art Included



Local Artist \$25,000

OPTIONAL

NFC PROGRAM TOTAL \$ 145,000-165,000

CONCRETE SLAB (FULL STUDIO DIMENSIONS 38X76)

Can be performed in-house or in-kind

est. \$ 0-40,000

NFC APPROVED INSTALLER NETWORK - INSTALLATION TEAM

Turn Key Fitness Court® Studio Assembly Art & Graphic Installation Installation Partner (separate agreement)

\$ 32,500

With Prevailing Wage Rates: \$34,500

Fitness Court® Studio installation is a specialized installation that requires expertise, proper certifications, and proven field experience

INSTALLATION & CONCRETE TOTAL ESTIMATE \$ 32,500-72,500



AWARDEE TOTAL
REMAINING
FUNDING
REQUIREMENT

PROGRAM # INSTALLATION

\$177,500-
\$237,500

Includes standard art collection, does not include prevailing wage rates

Fitness Court® Public Art



FITNESS
COURTS®

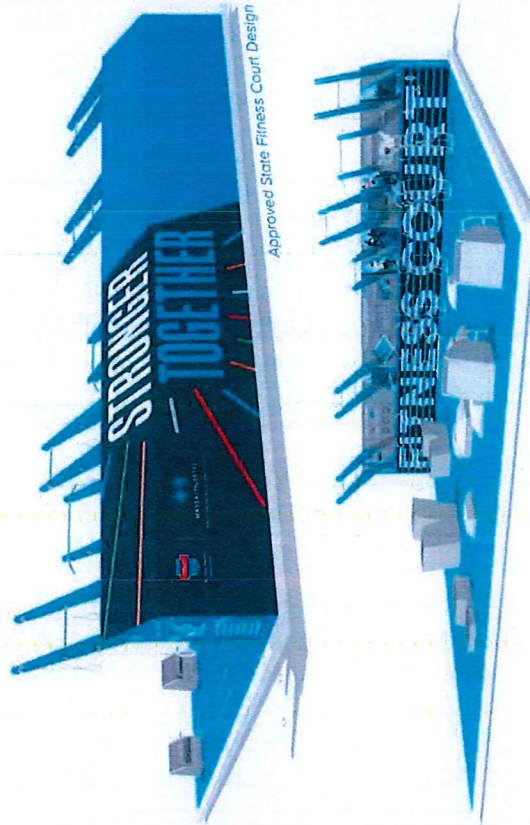

Approved State Fitness Court Design

2024 NFC State Sponsor Art Collection

No Additional Funding Required

EACH FITNESS COURT® IS A ONE-OF-A-KIND WORK OF ART.

NFC DESIGN STUDIO

Additional Funding Required:
\$10,000



Final design works in collaboration with State Sponsor

LOCAL ARTIST

Additional Funding Required:
\$25,000



Final design works in collaboration with State Sponsor

FEATURED ARTIST

Additional Funding Required:
\$35,000

United licenses available



2024 JEAN-MICHEL BASQUIAT

Harvey

Basquiat

Featured Artist Series

Licensed Public Art from America's most iconic Artists



Keith Haring was an American artist whose pop-art and graffiti-like work grew out of the New York City street culture of the 1980s. After public recognition he created larger scale works, such as colorful murals, many of them commissioned. His imagery has "become a widely recognized visual language".



**Inquire for full licensed collection*



Jean-Michel Basquiat is one of the best known artists of his generation and is widely considered one of the most important artists of the 20th century. His career in art spanned the late 1970s through the 1980s until his death in 1988, at the age of 27.



**Inquire for full licensed collection*

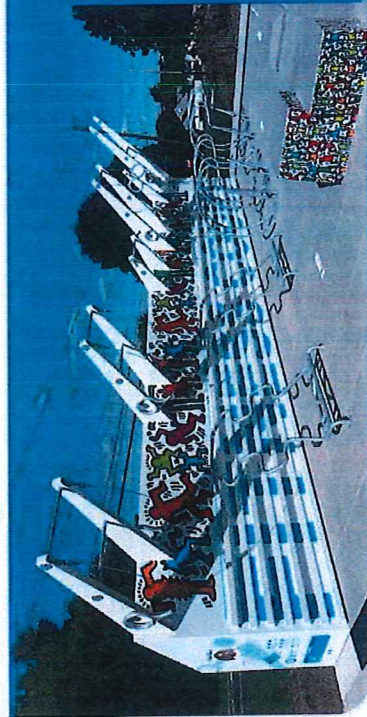

FEATURED ARTIST SERIES

Additional Funding Required
\$35,000

*Limited Licenses Available
for qualifying communities nationwide*



TOWN OF GROTON Board of Health

173 Main Street
Groton, Massachusetts 01450
Telephone (978) 448-1105
FAX (978) 448-1113

February 9, 2024

Community Preservation Committee
Town Hall
173 Main Street
Groton, MA 01450

Re: Town Manager's CPC Application 2025-06
Outdoor Fitness Court, 32 Playground Road

Dear Committee Members:

At its meeting on February 5, 2024, the Board of Health discussed the application submitted by the Town Manager, for the construction and installation of an outdoor fitness court on Town-owned property, the Lawrence Playground, located at 32 Playground Road. As stated in the application, the outdoor fitness court is part of a national campaign partially funded by a grant from Blue Cross Blue Shield.

The Board of Health supports the proposed location of the outdoor fitness court because it will be in the vicinity of the outdoor basketball court, the Christina Hanson Memorial Playground, the Groton Public Library, and the Nashua River Rail Trail. Use of the court will promote people's health and well-being and will be available to all at no cost to the users.

The Board voted unanimously, with Bob Fleischer, Evan Thackaberry, and Michelle Collette present, to recommend that the CPC approve the application so that it may be voted on at Town Meeting.

Respectfully submitted,

Michelle Collette, Chair
Groton Board of Health

cc: Town Manager



Groton Trails Committee

TOWN OF GROTON

173 Main Street
Groton, Massachusetts 01450-1237
(978) 448-1111
FAX: (978) 448-1115

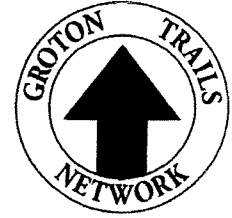

2 February 2024

Community Preservation Committee
Town Hall
173 Main Street
Groton, MA 01450

RE: Support for #2025-06 "Outdoor Fitness Court" Application for CPA Funds

Dear Community Preservation Committee Members:

The Groton Trails Committee wishes to express its support for the Town of Groton's application for \$237,500 from Groton's Community Preservation Act funds to fund the construction of an outdoor fitness court in the Town Field behind the Groton Public Library.

The Trails Committee strongly supports this project for the following reasons: a) In addition to providing public education about conservation issues, local geologic/glacial features, and cultural history, our committee's strategic goals include enhancing free outdoor recreational opportunities, increasing interactions among community members, and encouraging greater public fitness. These latter goals are directly served by this project; b) The Fitness Court's location behind the Groton Public Library, next to the Town Playground and Town Field (used for athletics, concerts, fireworks, etc.) will give it broad visibility in the community and provide easy access as well as off-Main St. parking; c) The Fitness Court's proximity to the Nashua River Rail Trail will make it an appealing and convenient destination for walkers and bikers using that well-used inter-town trail; d) Providing a new and unique recreational opportunity to the community with help from a \$50,000 grant and at no additional taxpayer cost for its construction, and only small sustainment costs beyond that, makes this a very cost-effective project; and e) The Parks Commission supports this project as proposed in the application.

Sincerely yours,

Paul G. Funch, Chair

Cc: Mark Haddad



TOWN OF GROTON

173 Main Street
Groton, Massachusetts 01450-1237
Tel: (978) 448-1111
Fax: (978) 448-1115

Select Board

Peter S. Cunningham, *Chair*
John F. Reilly, *Vice Chair*
Alison S. Manugian, *Clerk*
Rebecca H. Pine, *Member*
Matthew F. Pisani, *Member*

Town Manager
Mark W. Haddad

February 5, 2023

Community Preservation Committee
Groton Town Hall
173 Main Street
Groton, MA 01450

RE: Groton Town Manager Application
CPC – Outdoor Fitness Court

Dear Members of the Committee:

The Select Board respectfully requests your support for the proposed outdoor fitness court to be located at Town Field, adjacent to the Library and Basketball Court. The idea behind the outdoor fitness court is to create a space where community members of all ages can engage in physical activities and promote a healthy lifestyle. This court will provide a range of exercise equipment designed for outdoor use, catering to various fitness levels and preferences. The location at Town Field, with its proximity to the Library and other outdoor amenities, makes it an ideal spot to encourage community members to engage in physical activities while enjoying the beautiful surroundings.

We believe that the addition of an outdoor fitness center will greatly benefit our community in several ways. It will provide a free and accessible space for residents to exercise, promoting physical fitness and overall well-being. The center will also foster a sense of community, as individuals can come together and engage in healthy activities, encouraging social interaction and a sense of belonging.

We respectfully request that the Committee approves this application and present it to the voters for funding at the 2024 Spring Town Meeting. Thank you for your time and consideration.

Sincerely,
Groton Select Board

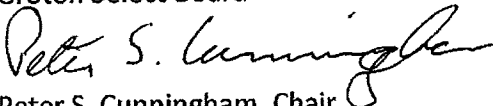
Peter S. Cunningham, Chair

PSC/mwh



TOWN OF GROTON
Park Commission
Town Hall
1st Floor Meeting Room

PARK COMMISSION
Brenden Mahoney, Chair
Anna Eliot, Vice Chair
Mary Jennings, Member
Jeffrey Ohringer, Member

Letter to the Town of Groton Community Preservation Committee in support of the 2025-06- Outdoor Fitness Court CPA Proposal

To: Groton Community Preservation Committee
Cc: Mark Haddad, Town Manager

Dear Community Preservation Committee Members,
At our February 6, 2024 meeting, the Park Commission unanimously voted to support the Town Manager's CPA proposal 2025-06 Outdoor Fitness Court, to create a National Fitness Campaign Fitness Court being constructed at Town Field on Playground Rd. This outdoor fitness court will benefit the community and has received grant funding from Blue Cross Blue Shield.

Respectfully,
The Groton Park Commission